



MARKS USA



Custom Lockset Division: Design from the Inside Out
Levers, Knobs & Escutcheons





MARKS CUSTOM LOCKSET DIVISION

Marks USA Custom Lockset Division product is manufactured with the quality engineered mechanical locksets that carry our Lifetime Mechanical Warranty. These products are non-stocked due to the large array of both designs and finishes and thus require longer lead times and minimum order quantities. This catalogue is only a sampling of the designs that can be supplied. Standard mortise & tubular lock trim are usually stocked and are available in normal lead times.

Table of Contents

Stainless Steel Cast Levers 2-14

Stainless Steel Tubular Levers..... 15-19

Standard Mortise & Tubular Lock Trim & Rose Styles..... 20

Custom Forged Brass Levers..... 21

Turnpieces 22

Custom Forged Brass Trim 23

Custom Escutcheon Plates 24-26

Additional Custom Designs..... 27-28

ArchiTech™ Designer Wireless Access Control 29

Lifetime Mechanical Limited Warranty

MARKS USA warrants that its products are free from defects in materials and workmanship. This warranty is limited to the lifetime of the door on which our lock is installed. In the event our product does not conform to this warranty, MARKS USA will repair or replace the product free of charge. This warranty does not cover defects or damage arising from improper installation, lack of or improper maintenance, improper storage, shipping and handling, ordinary wear and tear, misuse, abuse, accident, unauthorized service, or use with unauthorized non-MARKS products or parts. We reserve the right to make changes in materials, components or manufacturing methods. Liability under all warranties expressed or implied is limited to replacement of the defective goods. This warranty does not cover nor provide for the reimbursement or payment of incidental or consequential damages. Additionally, the company will not warrant ANSI A156.2 Grade 2 lever product installed in educational facilities and student housing.



Because common pin tumbler cylinders may be compromised by picking, drilling or key bumping, for applications where greater security is required, we created Marks USA HI-SECURITY™, constructed with multiple pin planes and sidebars, that are drill-, pick- and bump-resistant.



STAINLESS STEEL INVESTMENT CAST LEVER HANDLE

For Grade 1 Mortise & Tubular Locksets

SF001

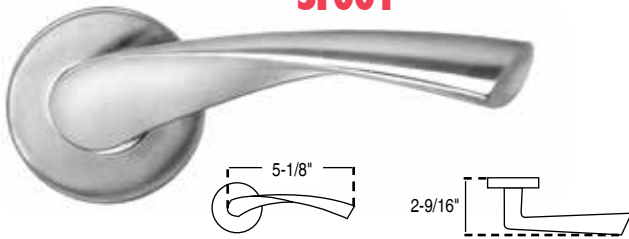

SF002



SF003

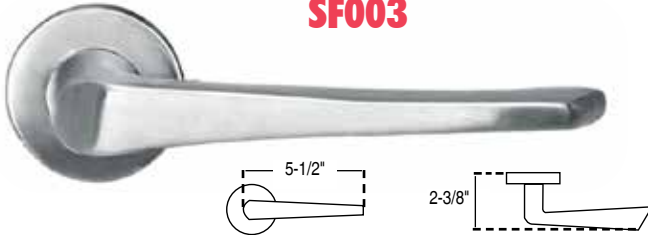

SF004



SF005

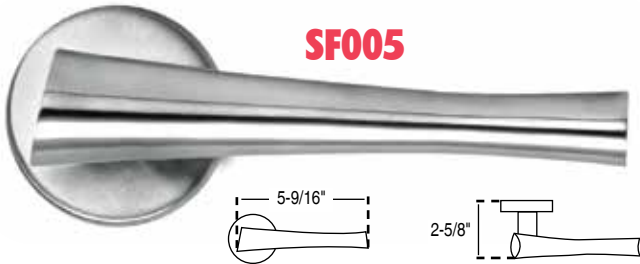

SF006

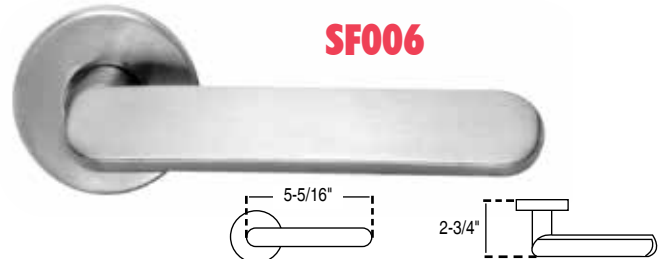

SF007



SF008



SF009



SF010

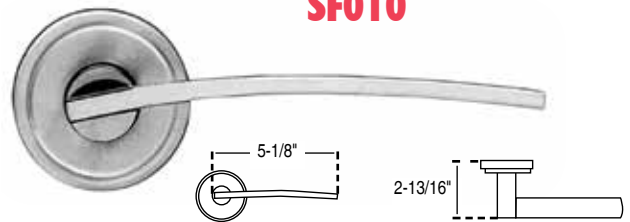

SF011

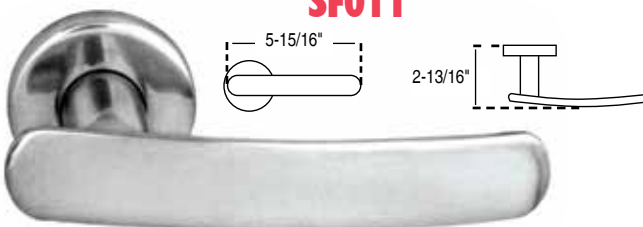

SF012

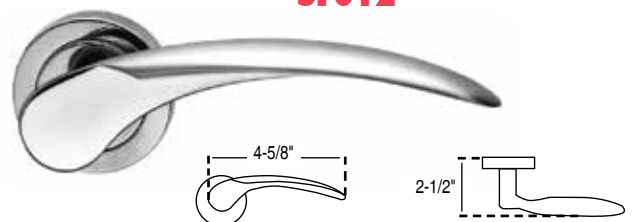

STAINLESS STEEL INVESTMENT CAST LEVER HANDLE

For Grade 1 Mortise & Tubular Locksets

SF013

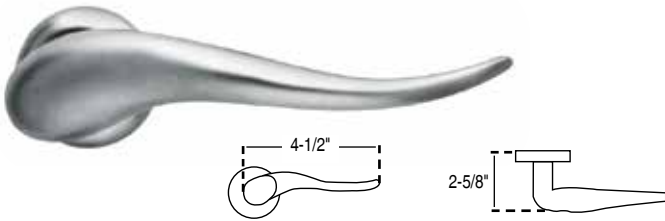

SF014

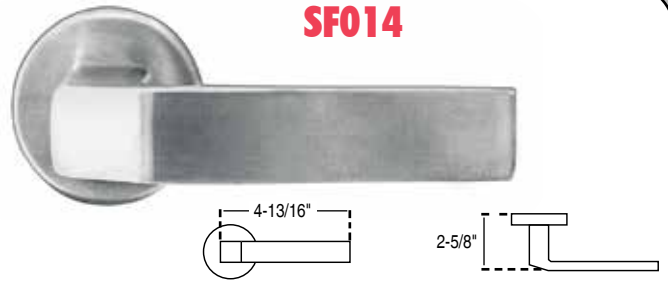

SF015

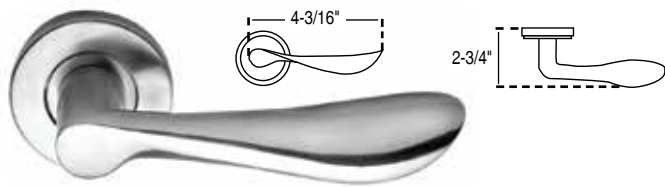

SF016

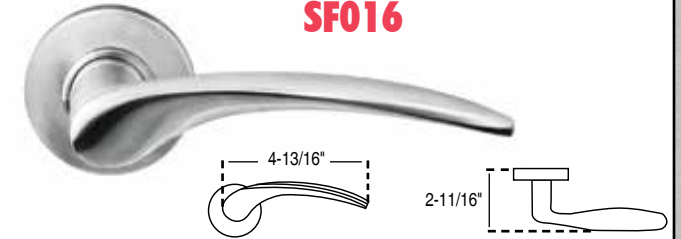

SF017

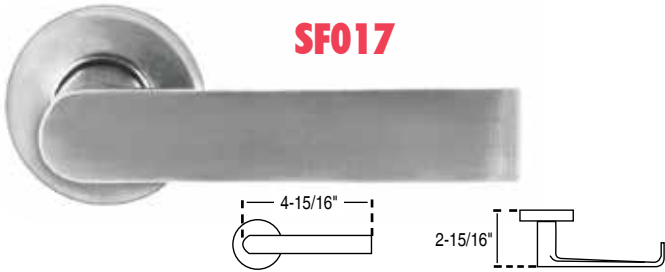

SF018



SF019

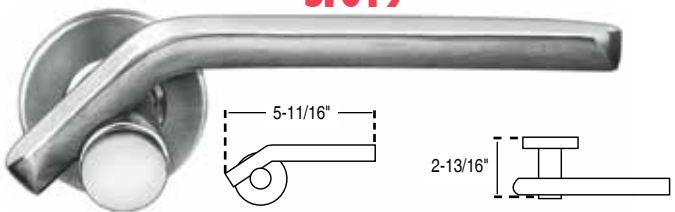

SF020

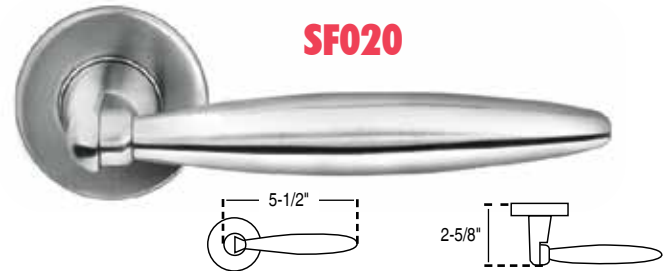

SF021

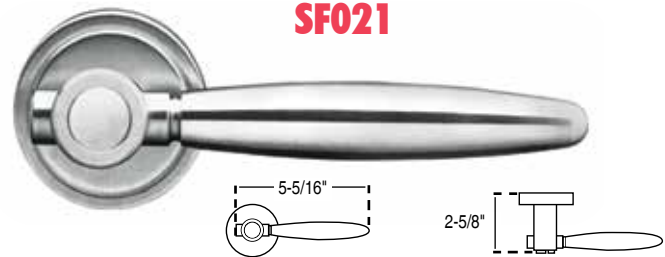

SF022

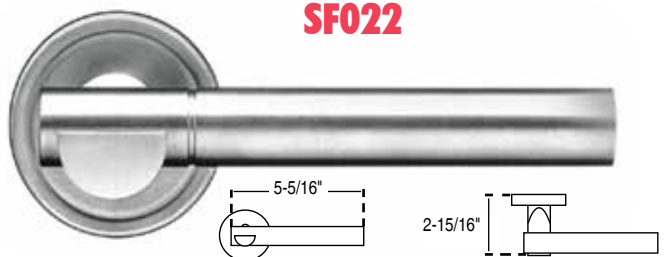

SF023

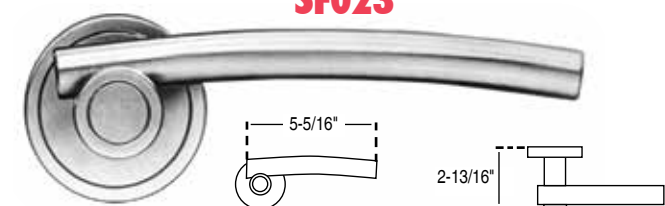

SF024

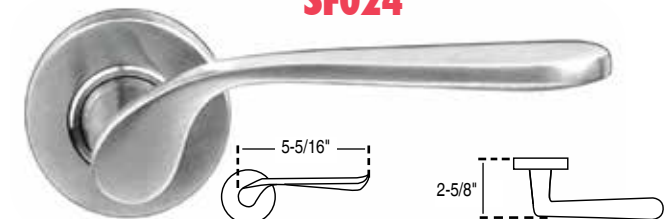

STAINLESS STEEL INVESTMENT CAST LEVER HANDLE

For Grade 1 Mortise & Tubular Locksets

SF025

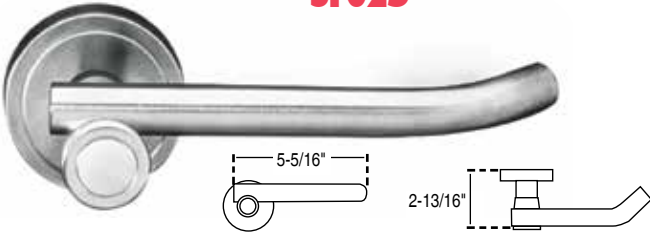

SF026

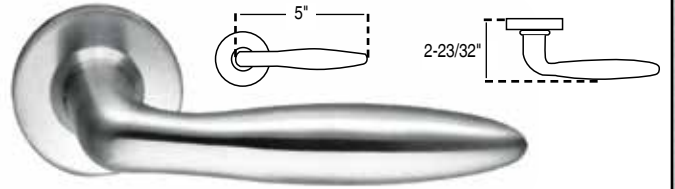

SF027

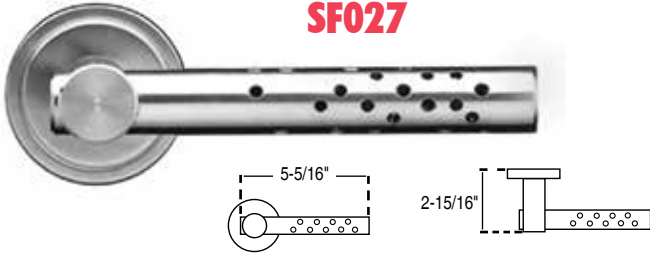

SF029

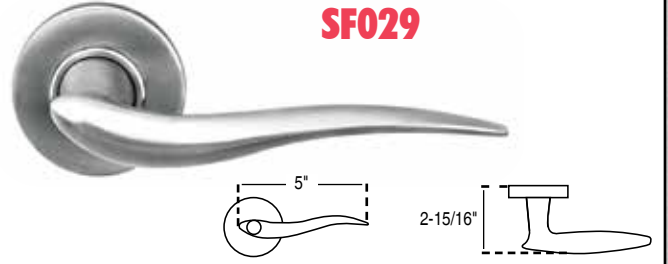

SF030

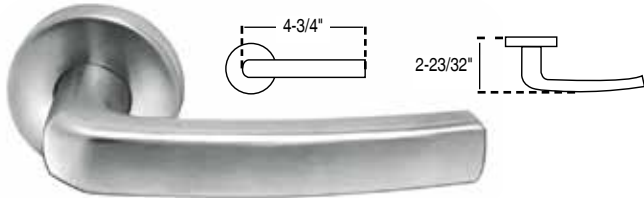

SF031

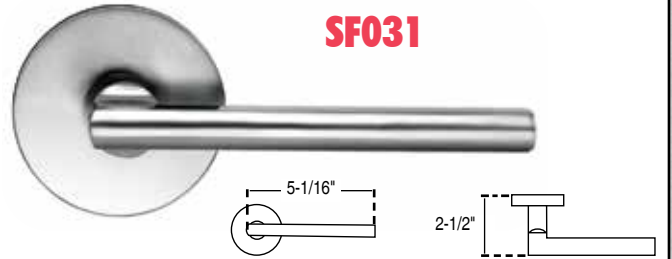

SF032

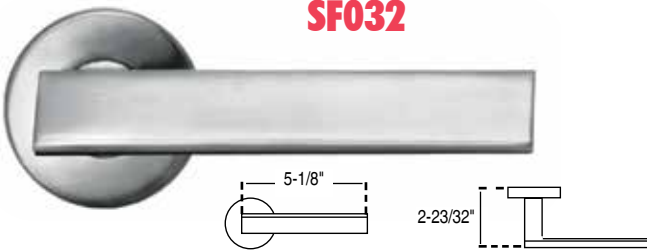

SF033



SF034

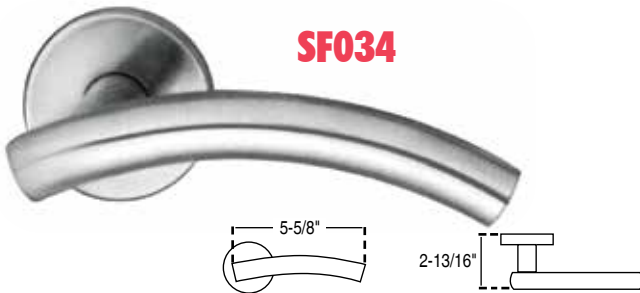

SF035

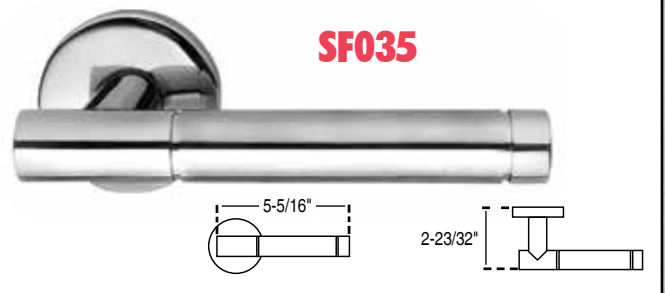

SF035A

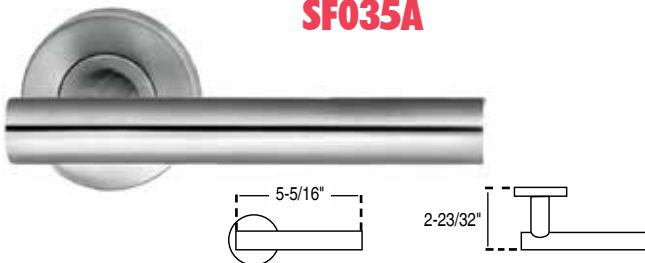

SF036



STAINLESS STEEL INVESTMENT CAST LEVER HANDLE

For Grade 1 Mortise & Tubular Locksets

SF037

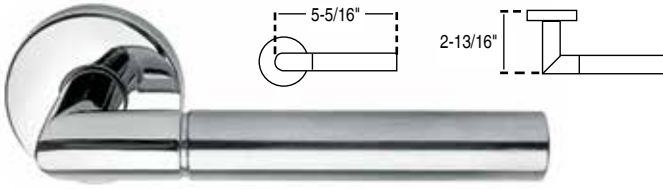

SF037A

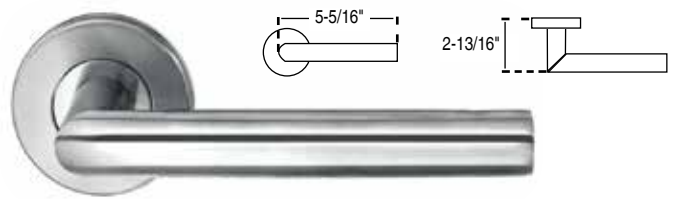

SF038

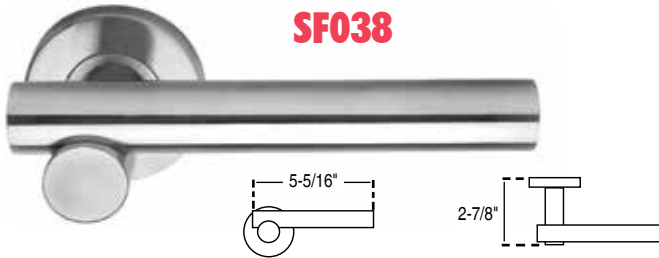

SF040

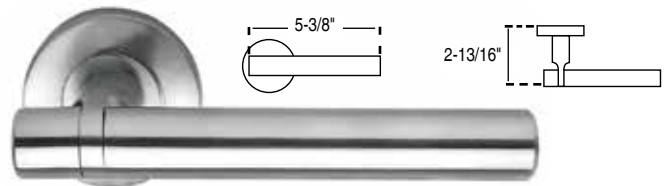

SF041

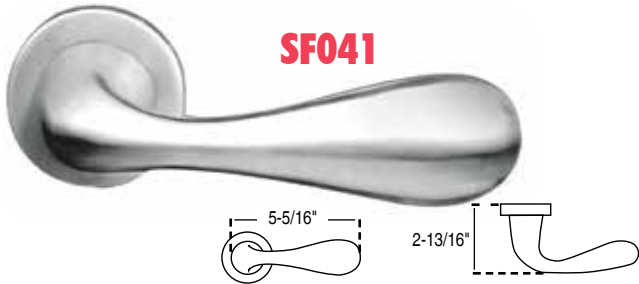

SF042

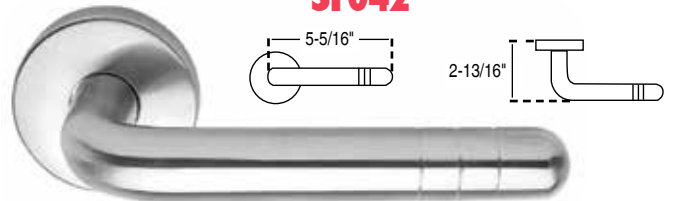

SF043



SF044



SF045



SF046



SF047

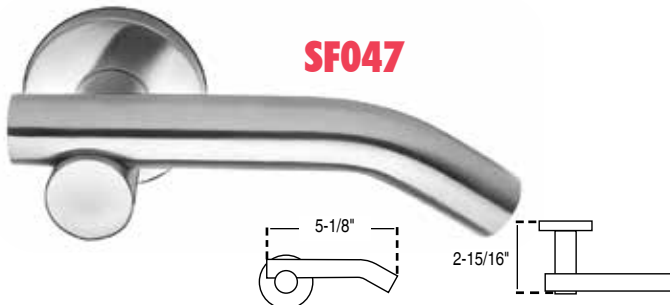

SF048

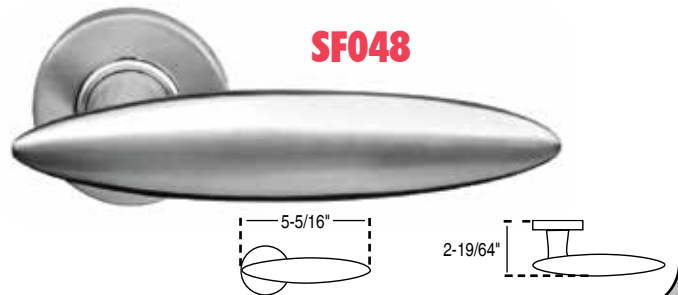

STAINLESS STEEL INVESTMENT CAST LEVER HANDLE

For Grade 1 Mortise & Tubular Locksets

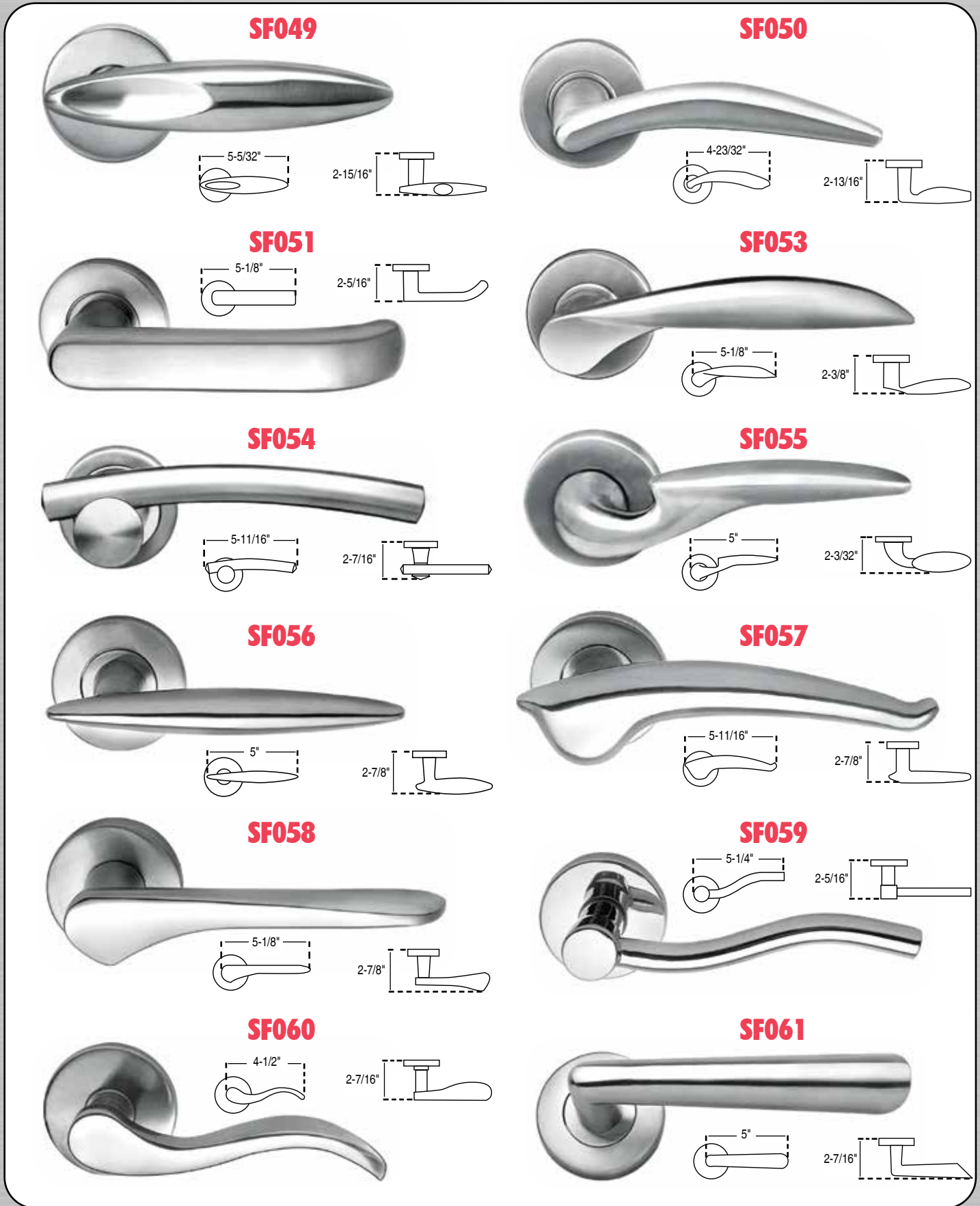

STAINLESS STEEL INVESTMENT CAST LEVER HANDLE

For Grade 1 Mortise & Tubular Locksets

SF062

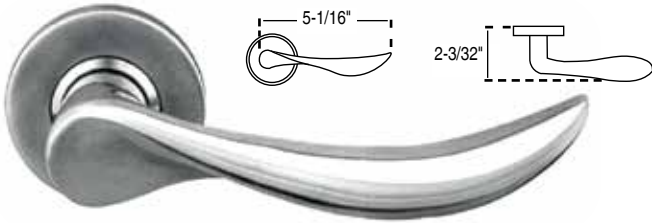

SF063

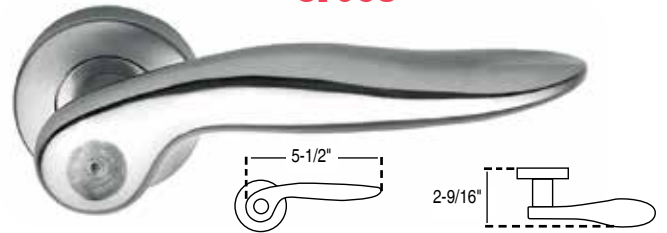

SF064

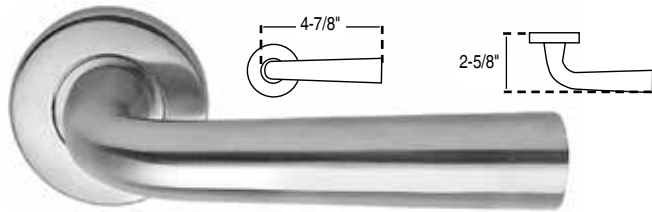

SF065

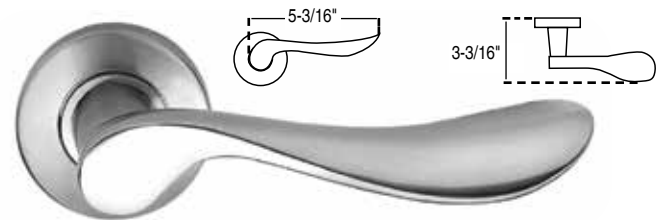

SF067



SF068

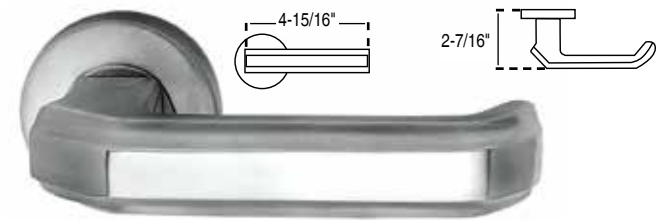

SF069

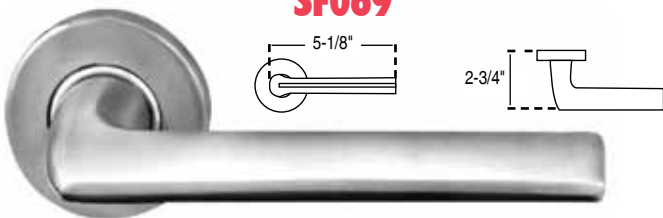

SF070

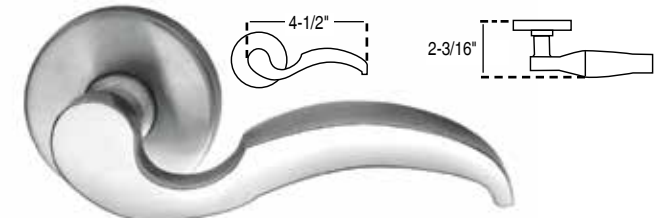

SF071

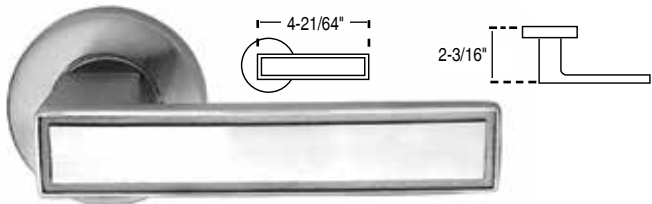

SF072

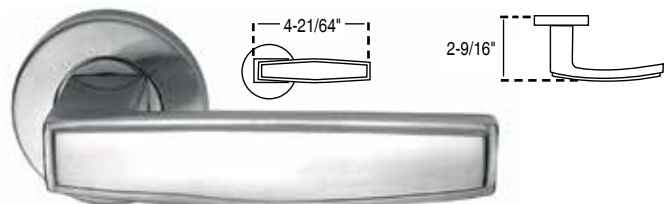

SF073

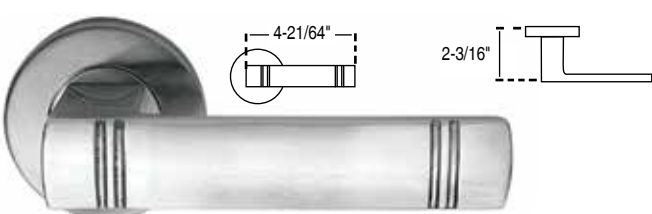

SF074

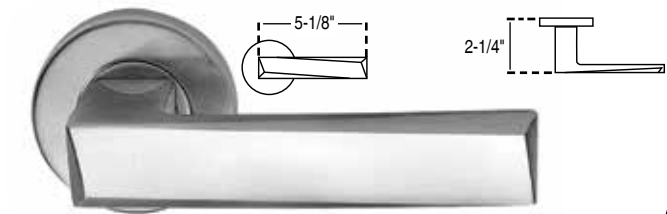

STAINLESS STEEL INVESTMENT CAST LEVER HANDLE

For Grade 1 Mortise & Tubular Locksets

SF075

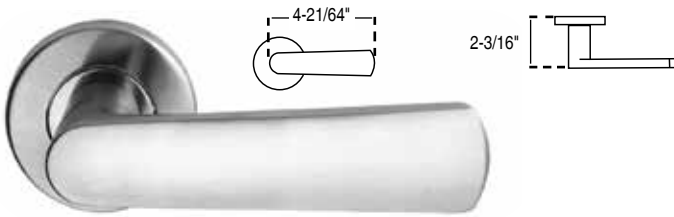

SF076

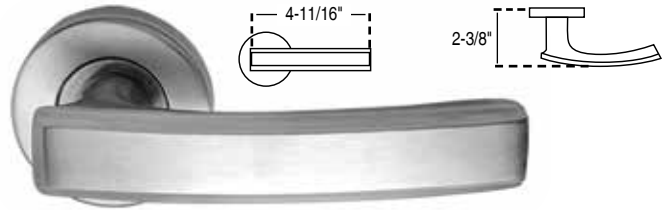

SF077

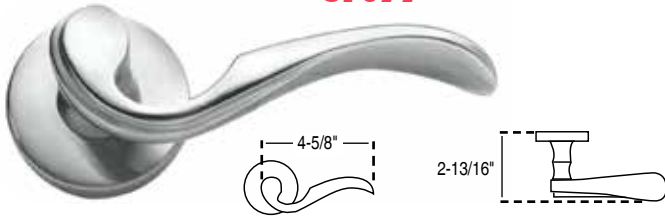

SF078

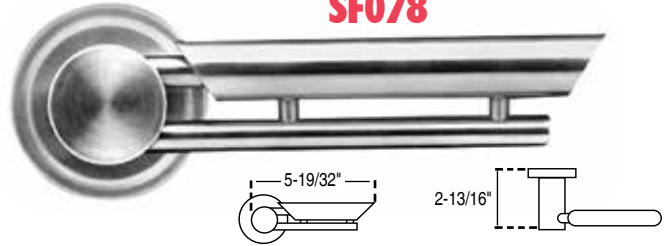

SF080

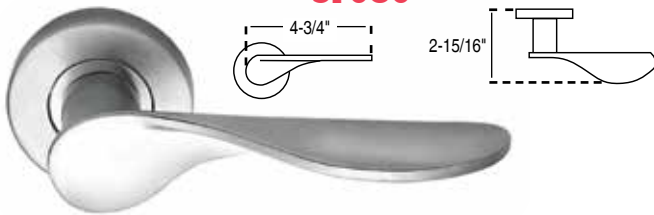

SF081

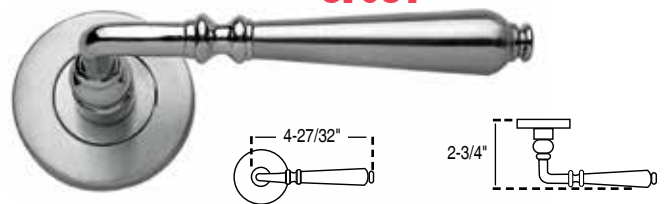

SF082

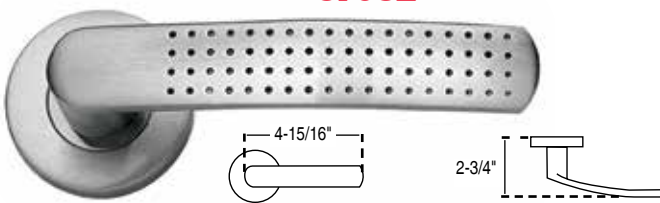

SF083

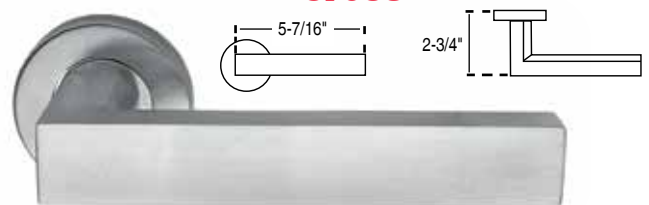

SF084

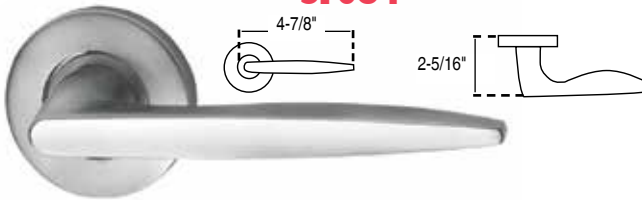

SF085

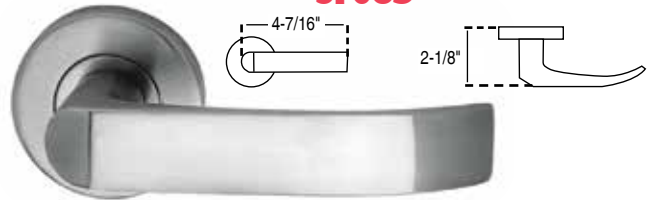

SF086

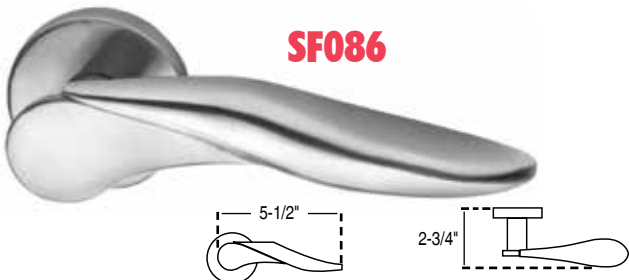

SF087

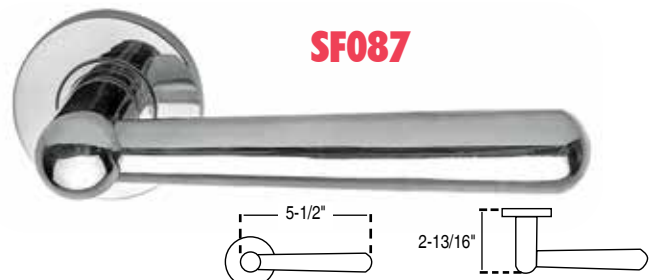

STAINLESS STEEL INVESTMENT CAST LEVER HANDLE

For Grade 1 Mortise & Tubular Locksets

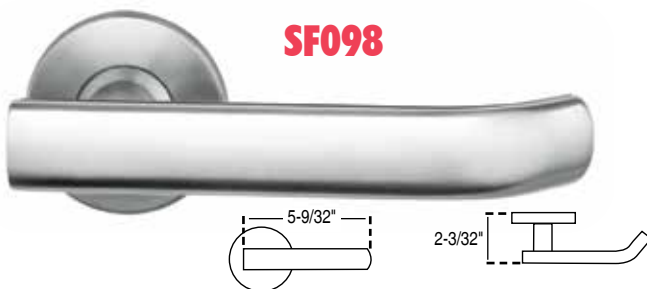
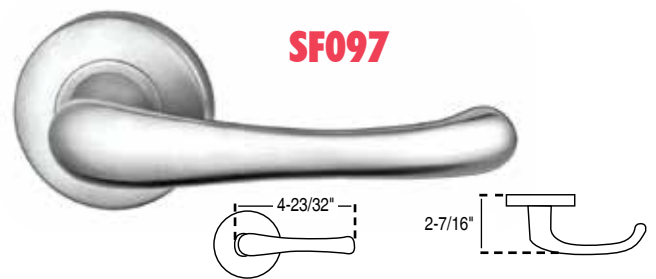
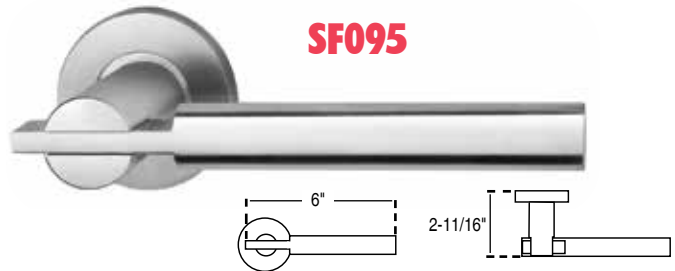
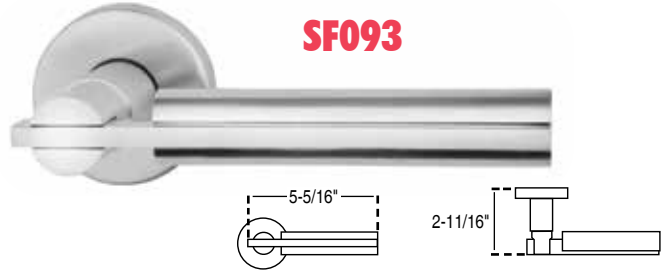
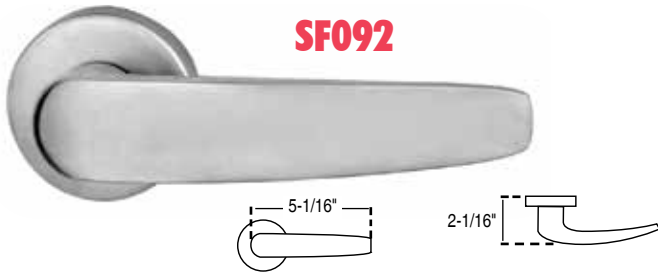
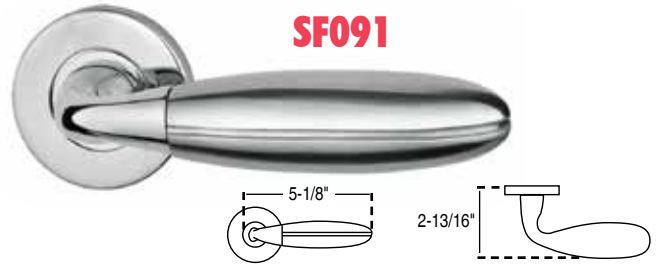
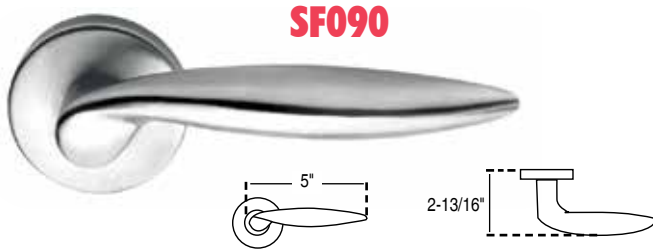
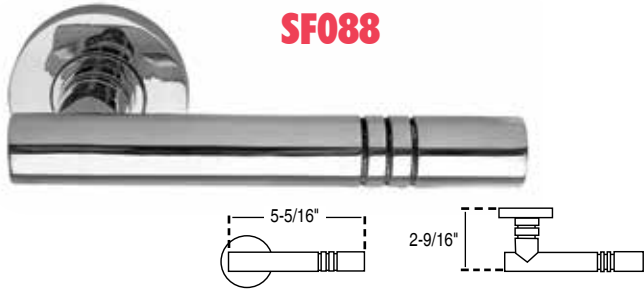

STAINLESS STEEL INVESTMENT CAST LEVER HANDLE

For Grade 1 Mortise & Tubular Locksets

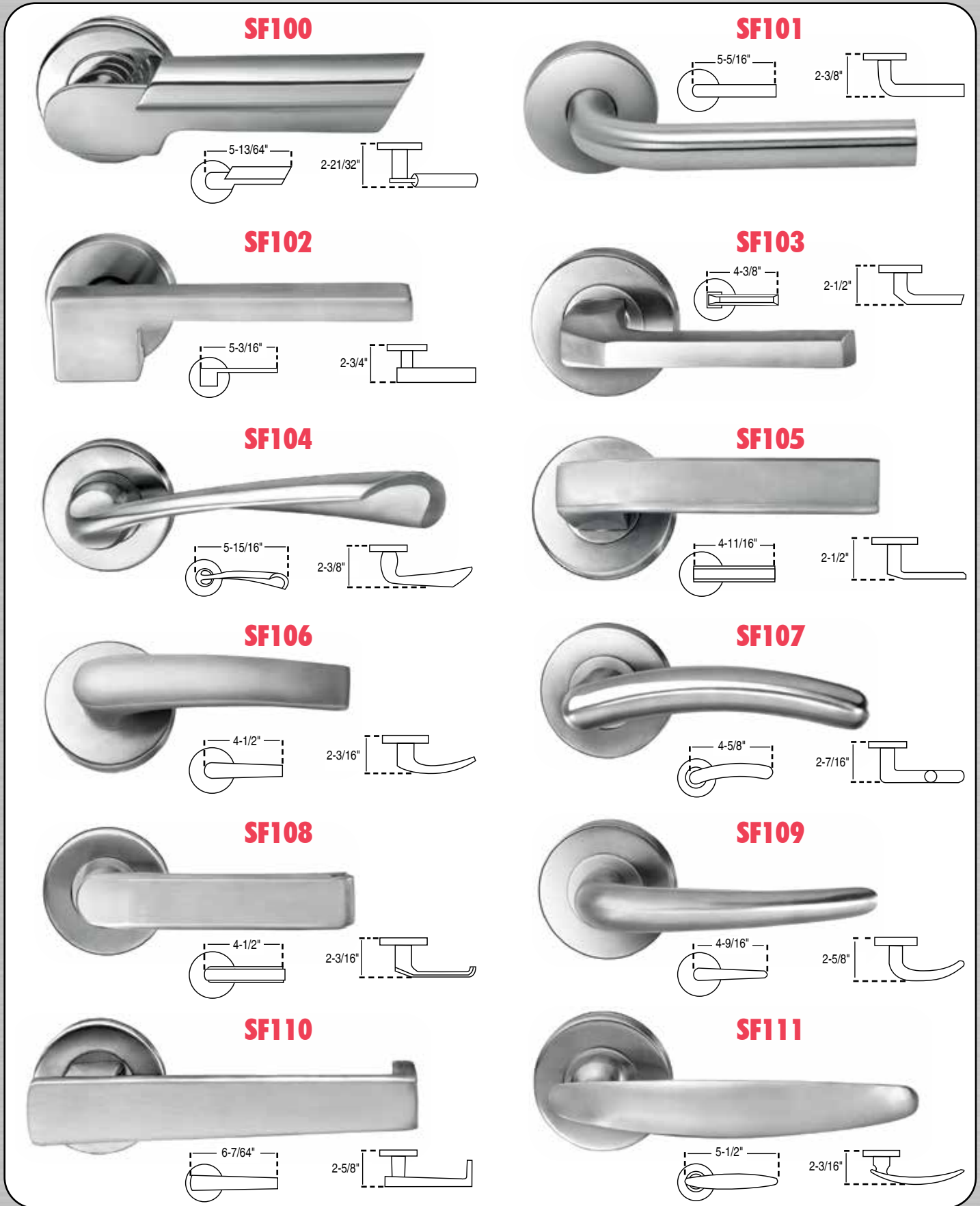

STAINLESS STEEL INVESTMENT CAST LEVER HANDLE

For Grade 1 Mortise & Tubular Locksets

SF112

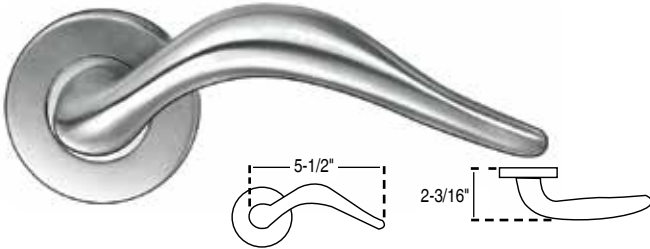

SF113

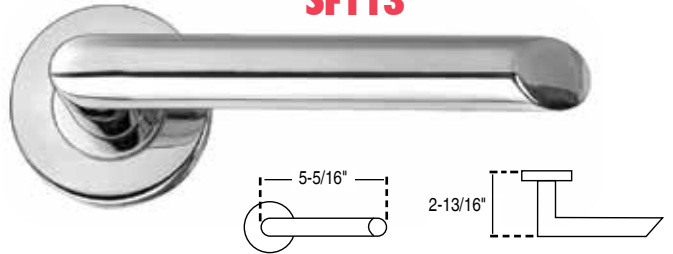

SF114

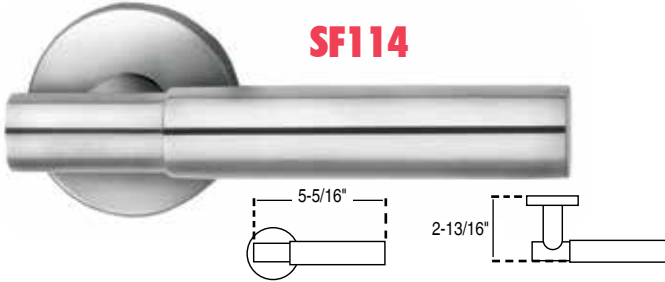

SF115

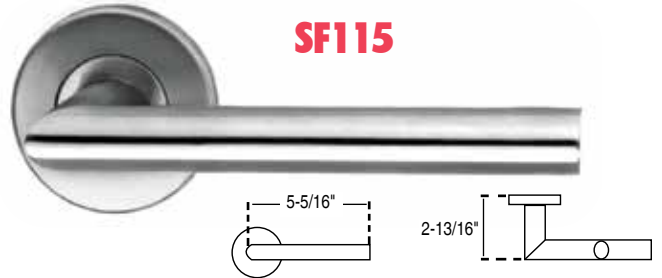

SF116

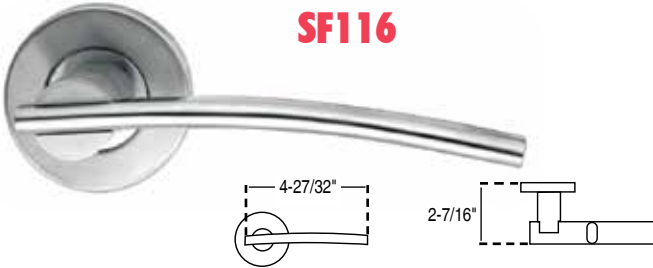

SF117

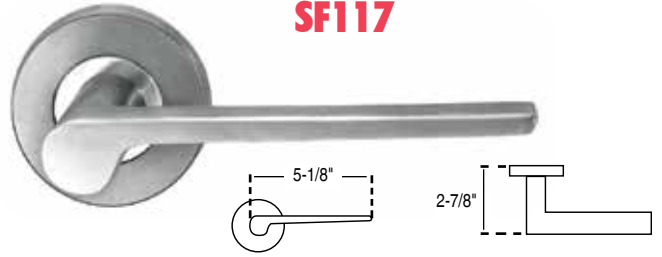

SF118

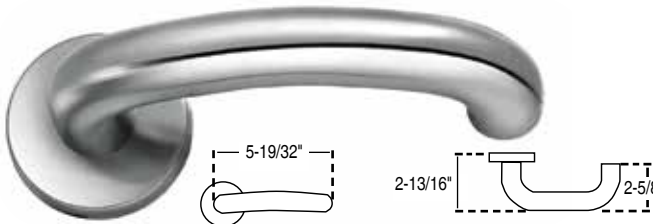

SF119

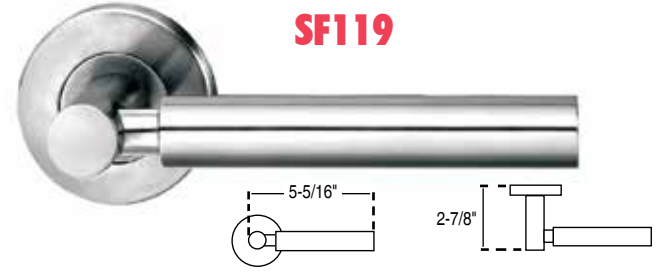

SF120

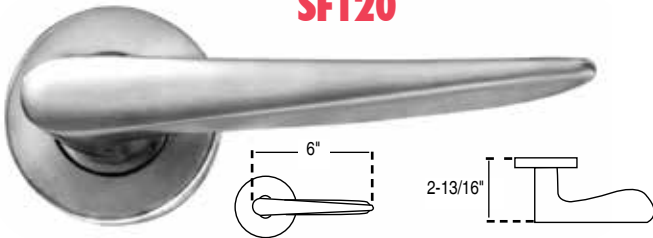

SF121

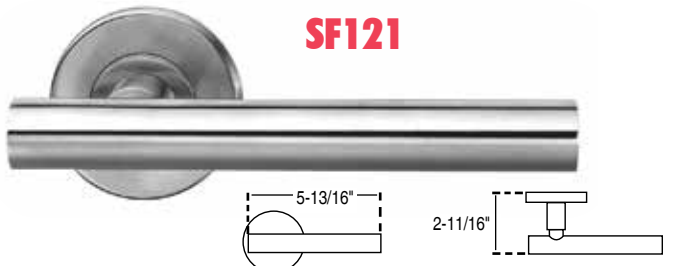

SF122

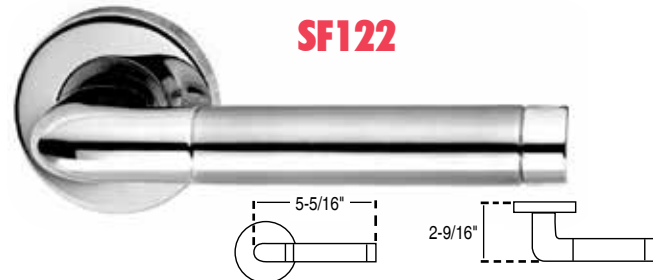

SF123

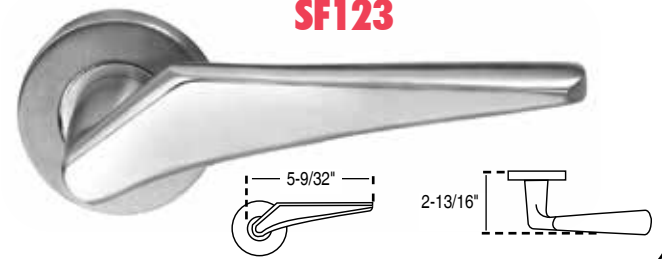

STAINLESS STEEL INVESTMENT CAST LEVER HANDLE

For Grade 1 Mortise & Tubular Locksets

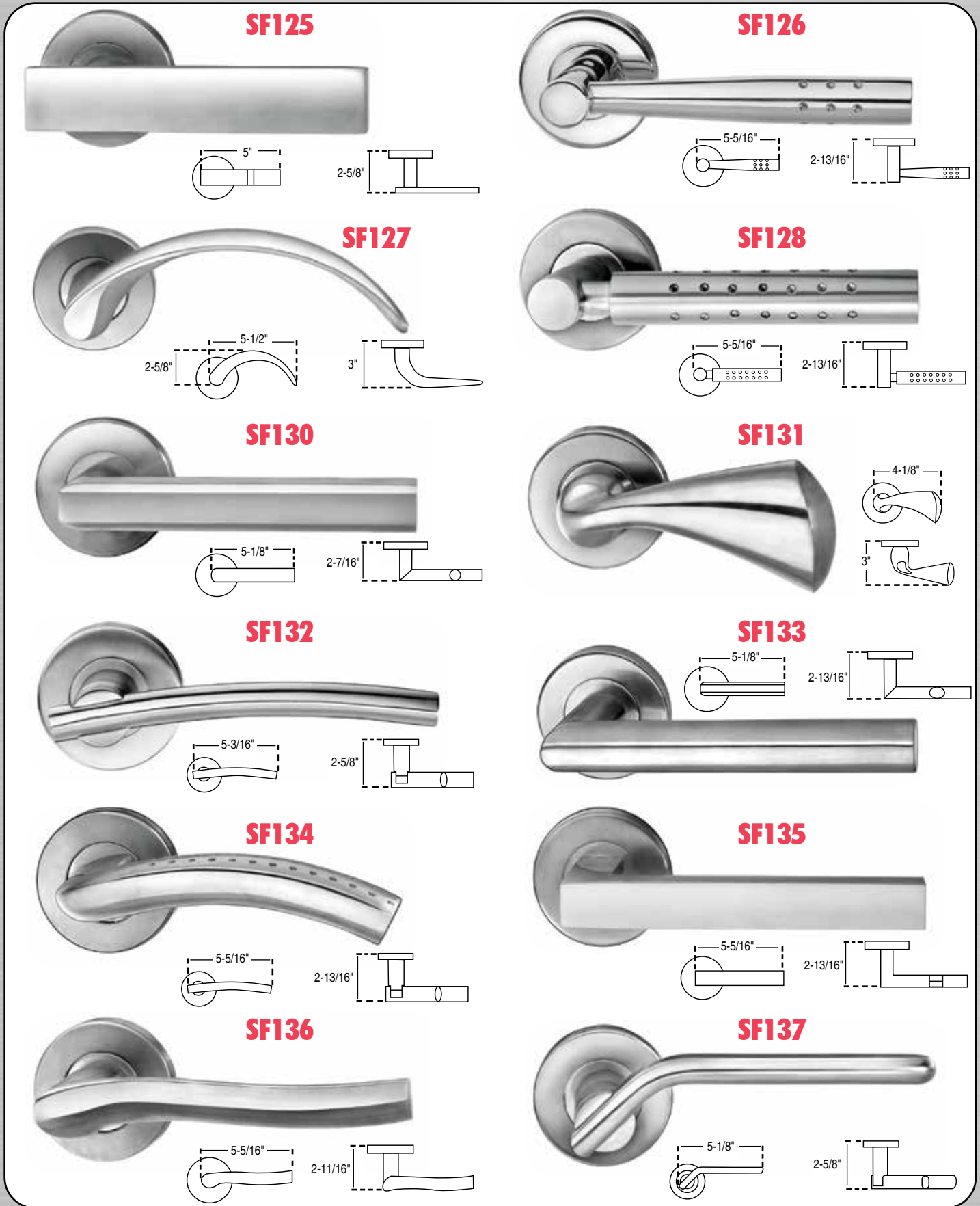

STAINLESS STEEL INVESTMENT CAST LEVER HANDLE

For Grade 1 Mortise & Tubular Locksets

<p>SF138</p>	<p>SF139</p>
<p>SF140</p>	<p>SF141</p>
<p>SF142</p>	<p>SF144</p>
<p>SF145</p>	<p>SF146</p>
<p>SF147</p>	<p>SF148</p>
<p>SF149</p>	<p>SF150</p>

STAINLESS STEEL INVESTMENT CAST LEVER HANDLE

For Grade 1 Mortise & Tubular Locksets

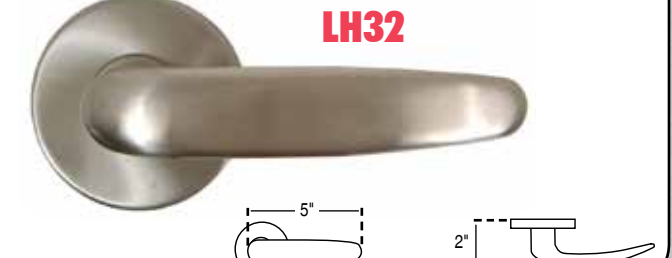
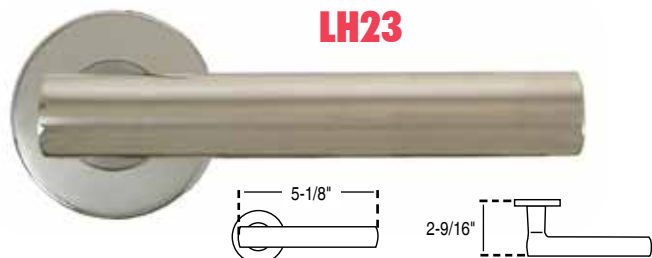
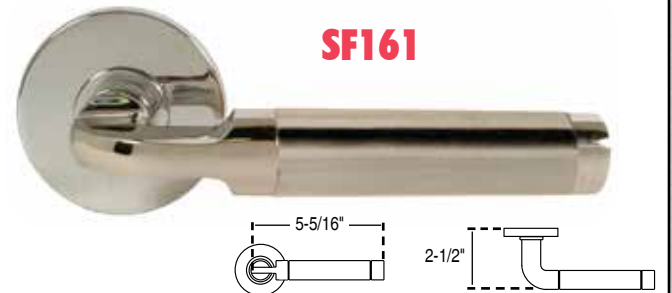
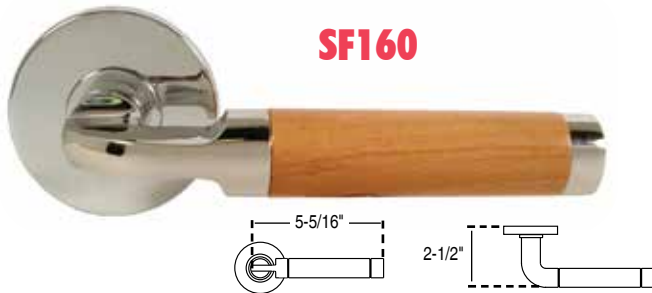
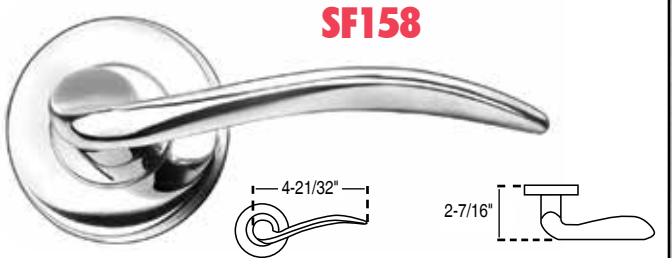
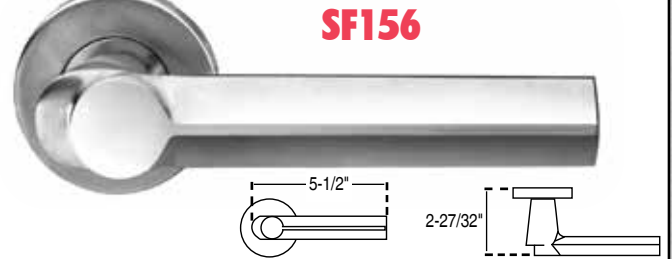
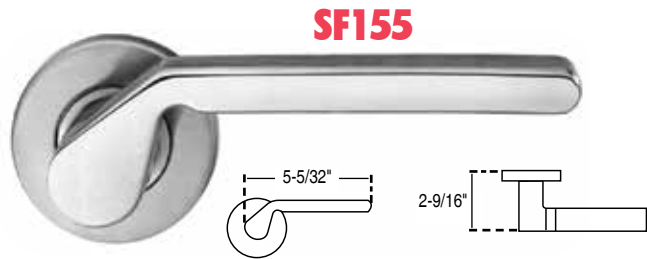
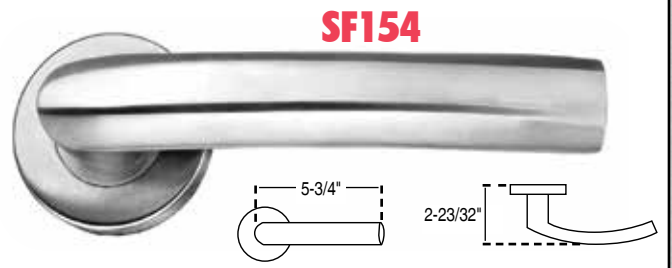
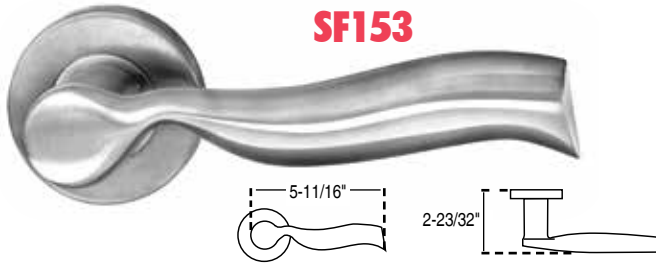
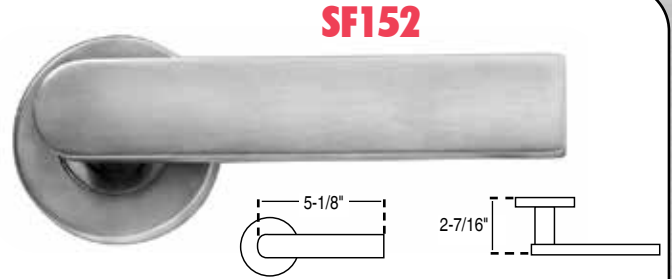
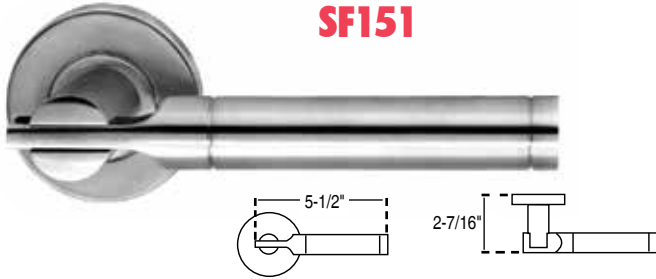

STAINLESS STEEL TUBULAR LEVERS

For Tubular Locksets

SD001

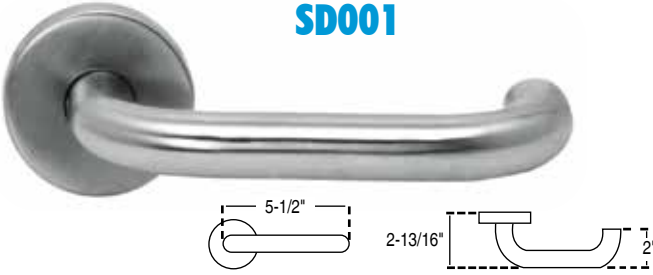

SD002



SD002A

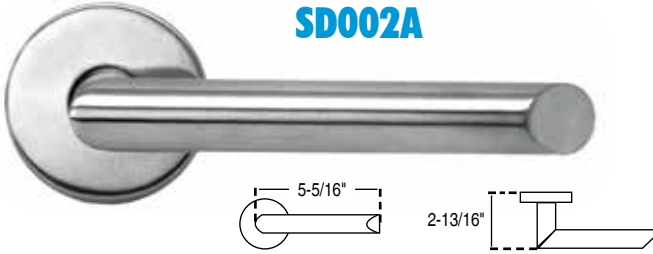

SD002B



SD003



SD004

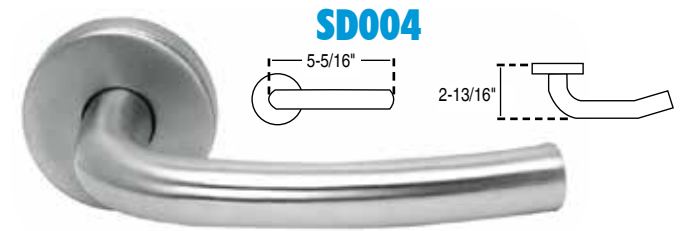

SD005

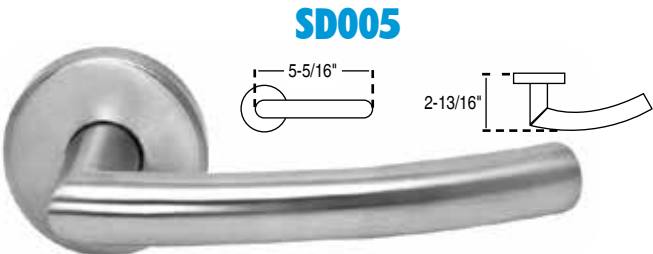

SD006

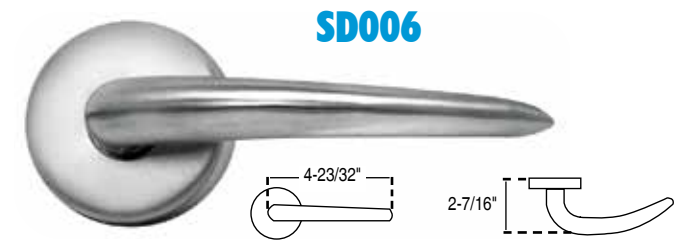

SD007

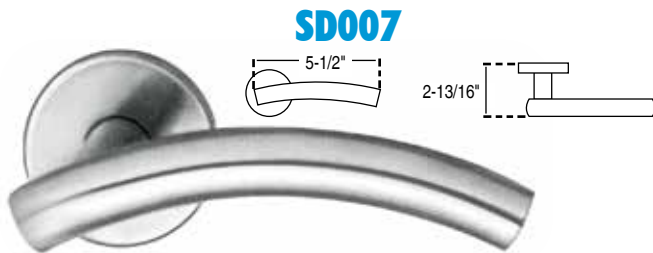

SD008



SD009



SD010

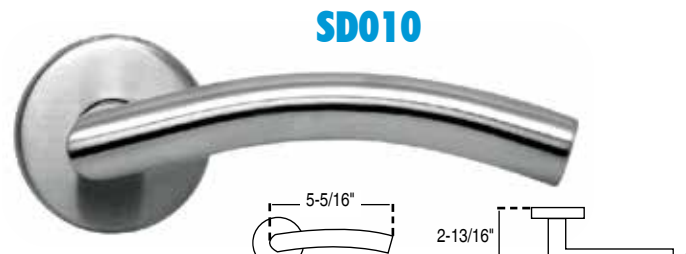

STAINLESS STEEL TUBULAR LEVERS

For Tubular Locksets

SD011

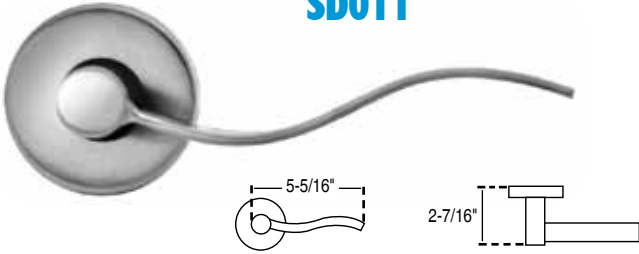

SD012



SD013

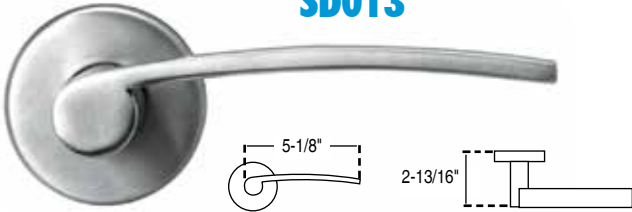

SD014

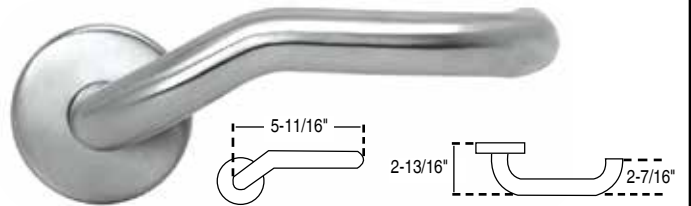

SD015

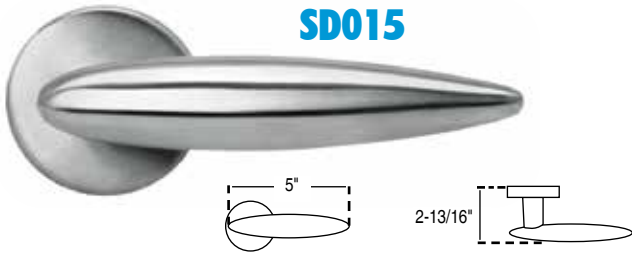

SD015A

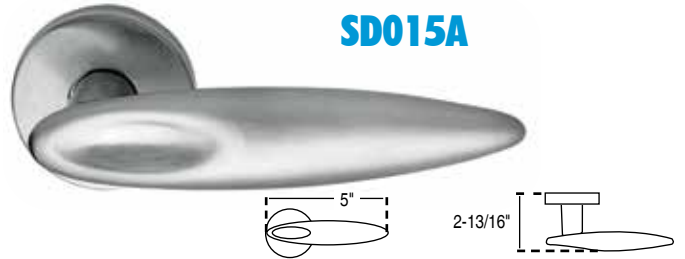

SD016

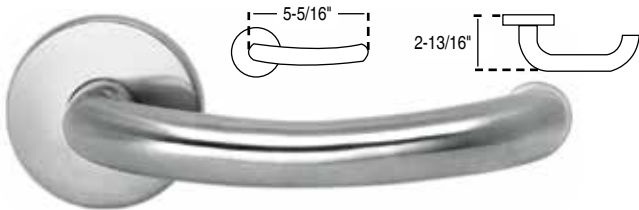

SD017

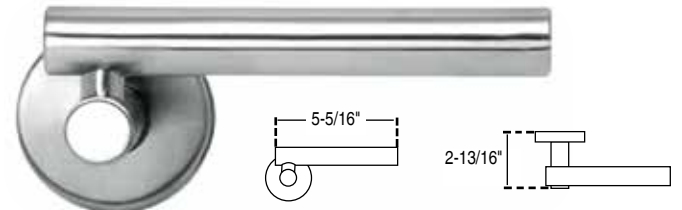

SD018

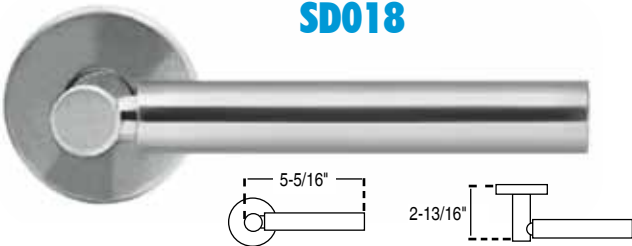

SD019



SD020

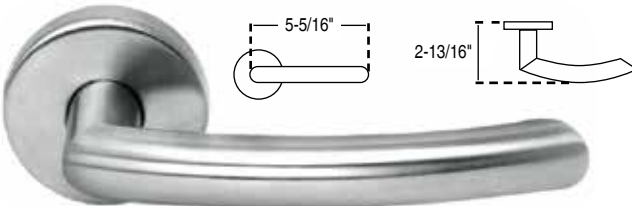

SD021

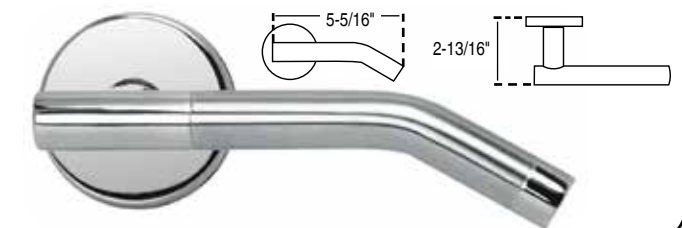

STAINLESS STEEL TUBULAR LEVERS

For Tubular Locksets

SD022



SD023



SD024

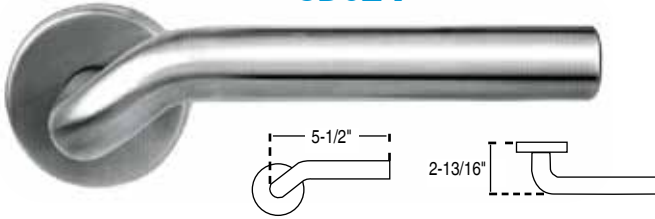

SD025

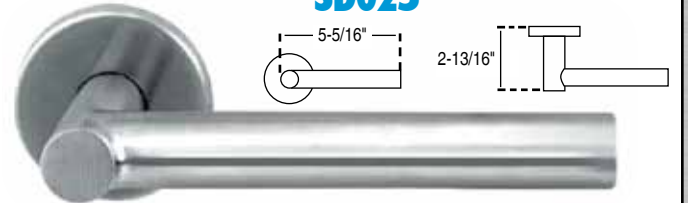

SD026

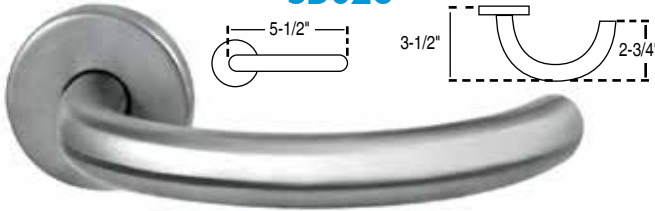

SD027



SD028

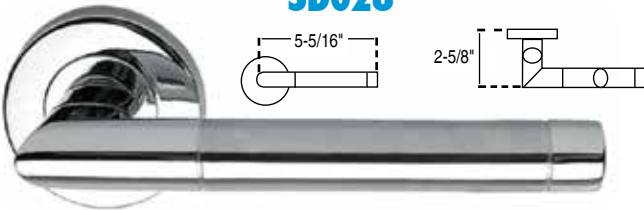

SD029

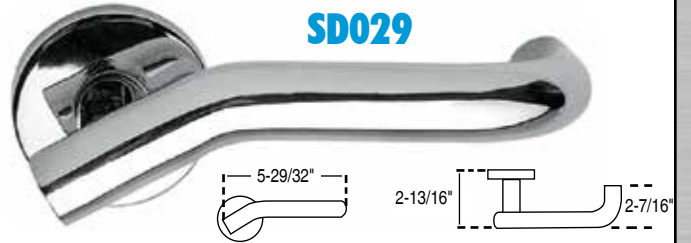

SD030



SD031



SD032

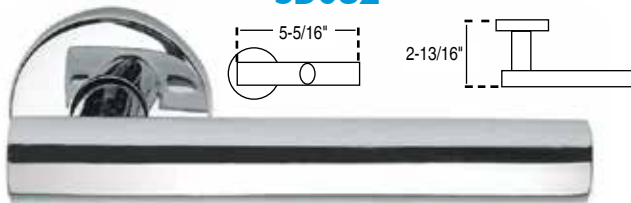

SD033

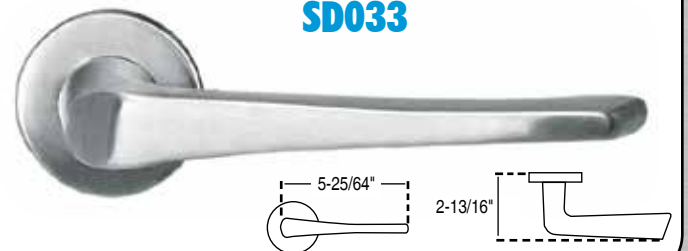

STAINLESS STEEL TUBULAR LEVERS

For Tubular Locksets

SD034

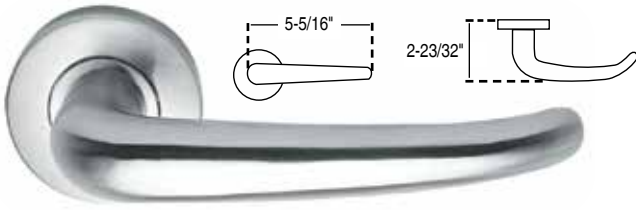

SD035

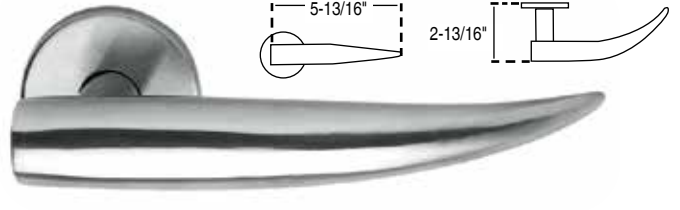

SD036

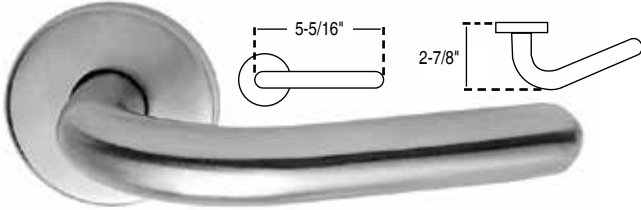

SD037

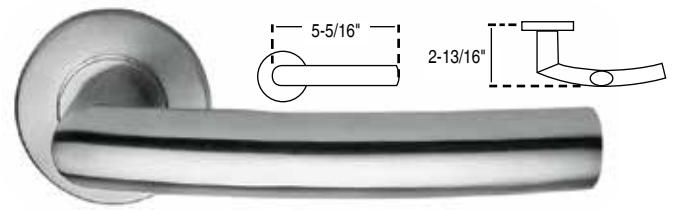

SD038

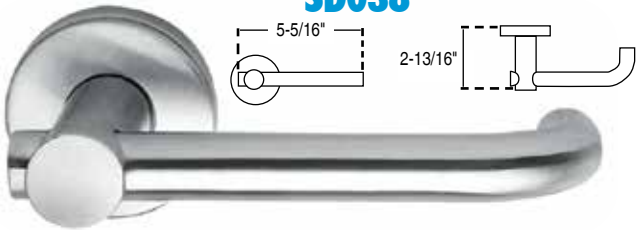

SD039

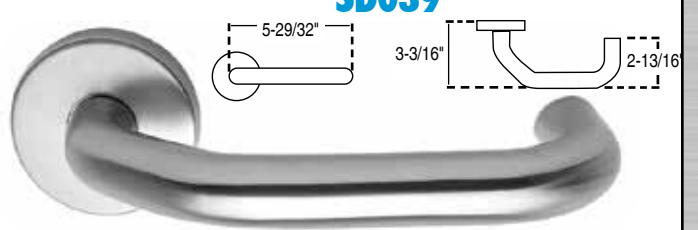

SD040

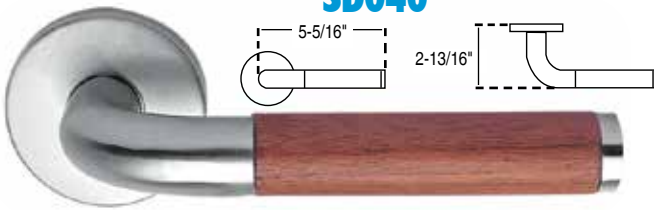

SD041

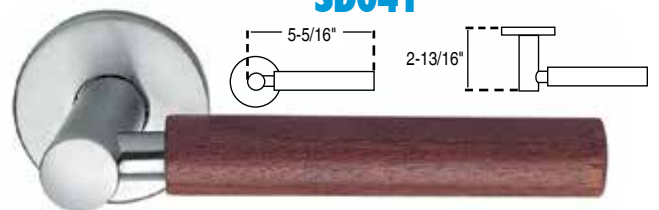

SD042

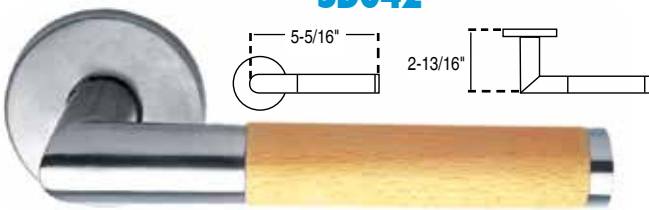

SD043

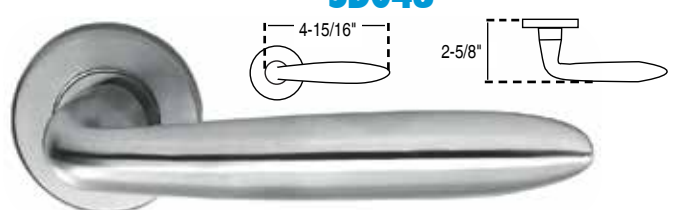

SD046

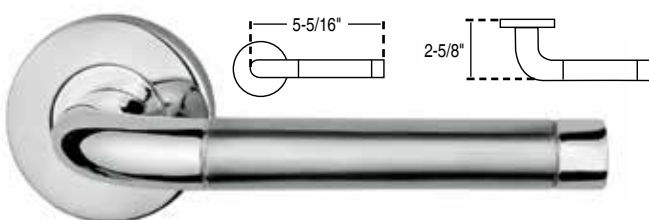

SD047

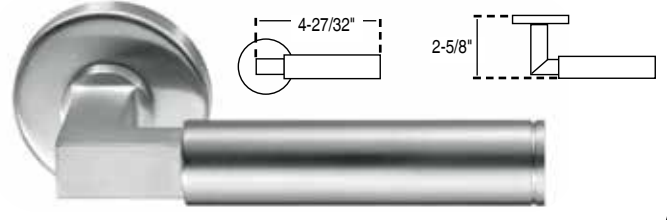

STAINLESS STEEL TUBULAR LEVERS

For Tubular Locksets

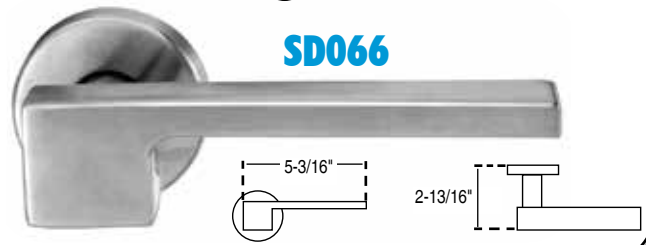
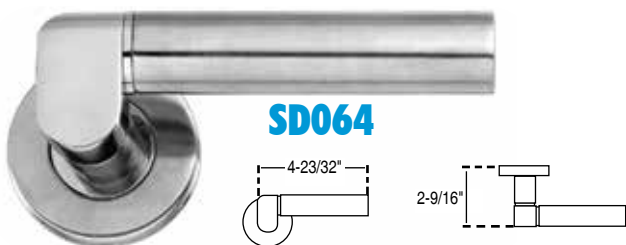
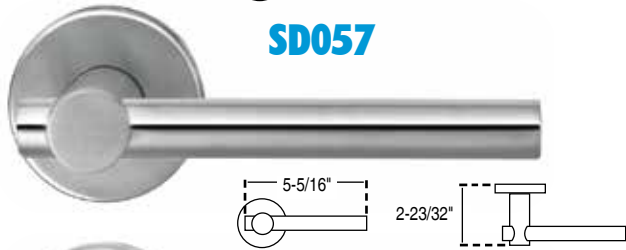
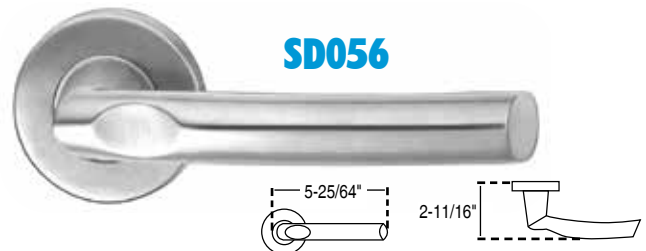
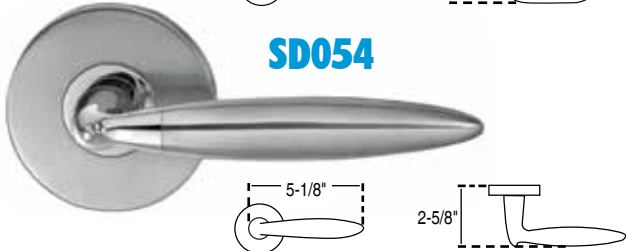
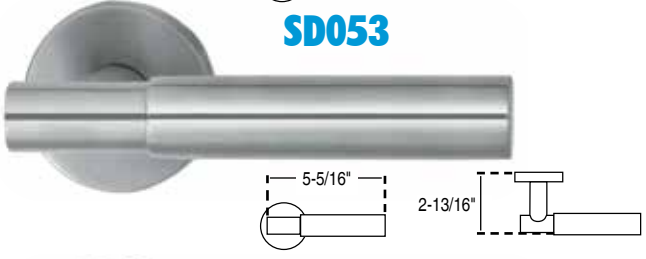
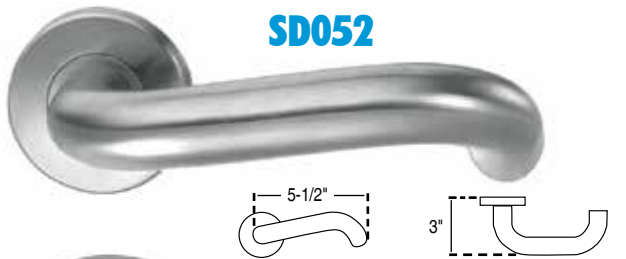
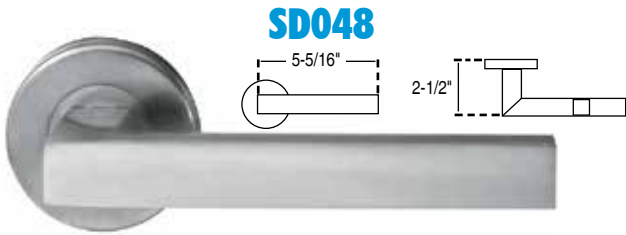

STANDARD MORTISE & TUBULAR LOCK TRIM & ROSE STYLES

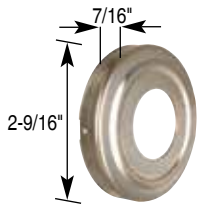

ROSE RR

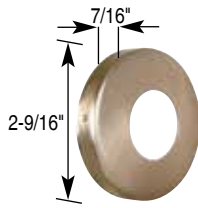

ROSE RW

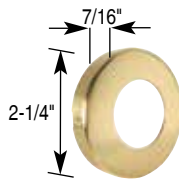

ROSE RS

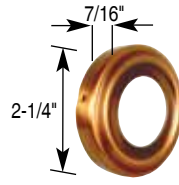

ROSE RQ

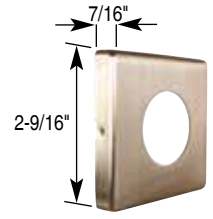

ROSE RX

NOTE: Roses are available in a wide variety of finishes



ROUND 10

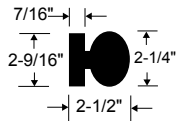

STANHOPE 5644

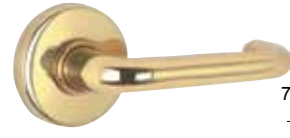
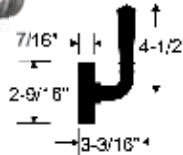

PLAZA 82

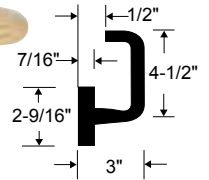

BALL 20/30

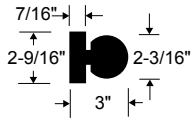

MONACO 57

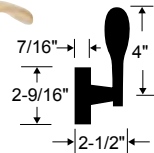

Dayton 83

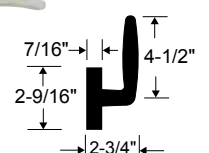

ECLIPSE 60

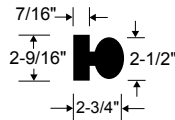

TOWNE 72

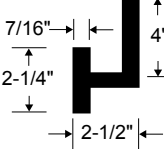

CRESCENT 86

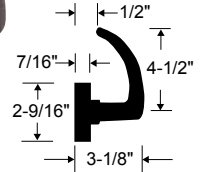

MADISON 52

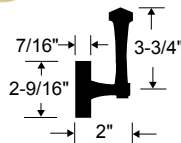

MAXWELL 77

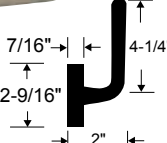

AMERICAN 92

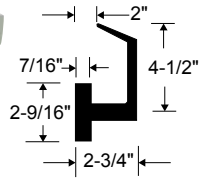

OMNI 78

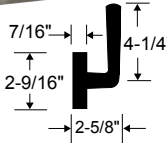

TITAN 96

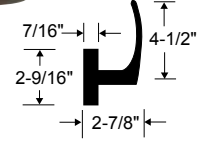

CUSTOM FORGED BRASS LEVERS

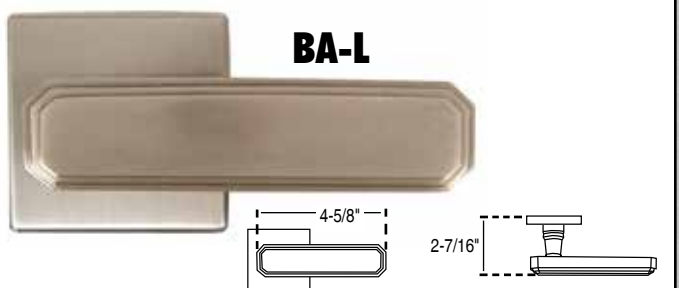
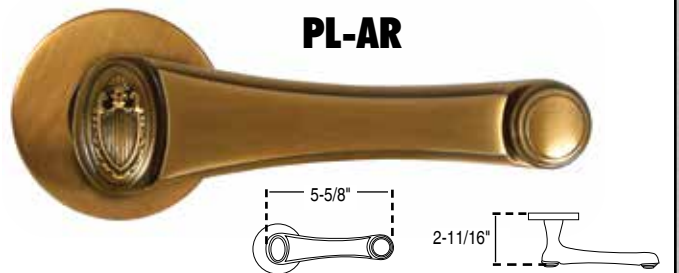
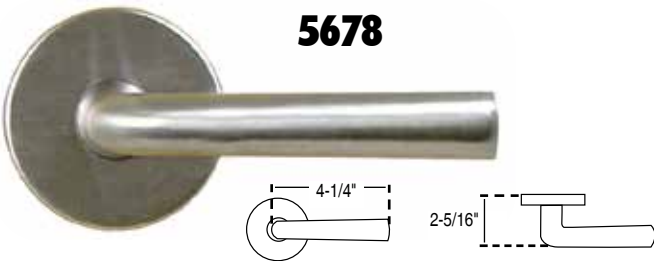
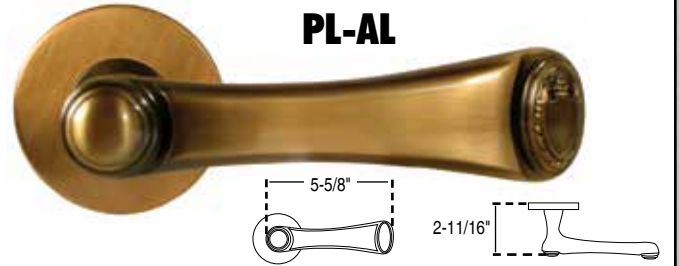
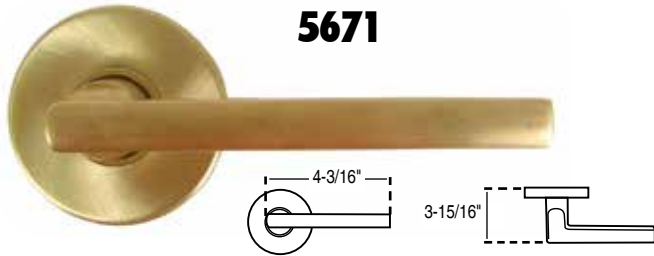
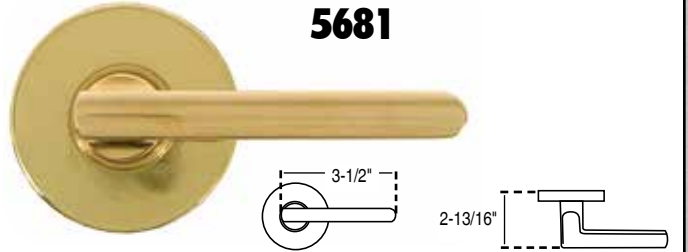
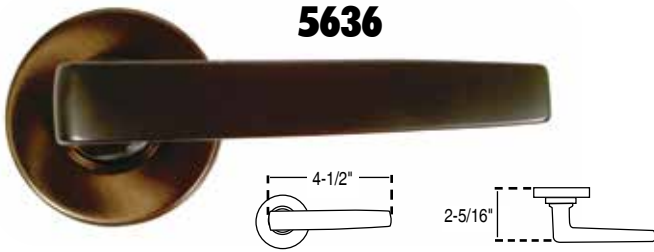
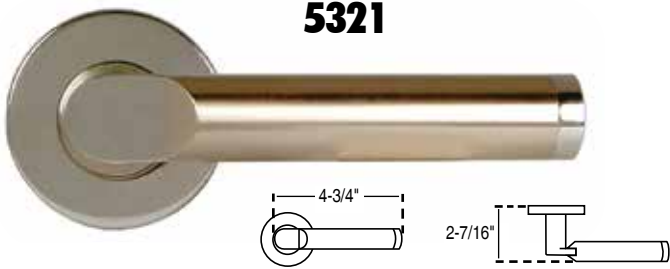

TURNPEICES

OPTION CODE T1

Base Metal: Brass & Stainless Steel

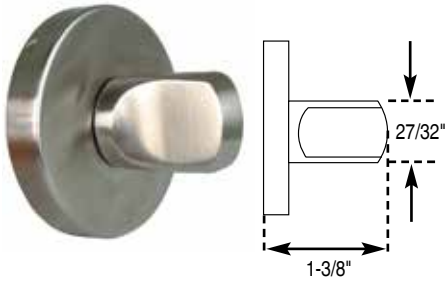

OPTION CODE T2

Base Metal: Stainless Steel

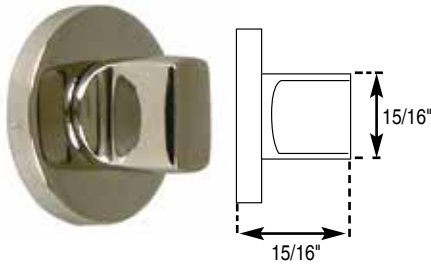

OPTION CODE T3

Base Metal: Zinc

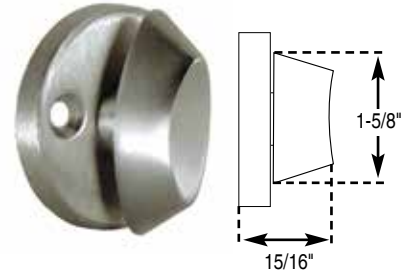

OPTION CODE T4

Base Metal: Brass & Stainless Steel

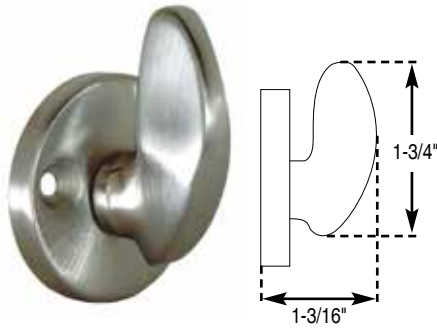

OPTION CODE T5

Base Metal: Stainless Steel

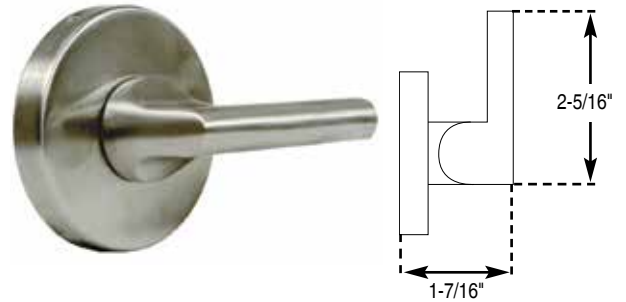

OPTION CODE T6

Base Metal: Stainless Steel

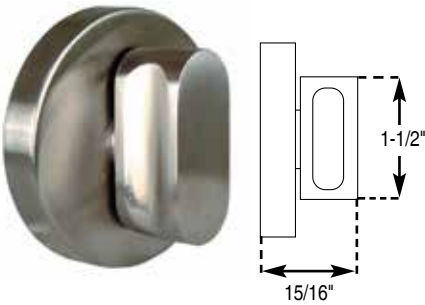

OPTION CODE T7

Base Metal: Brass

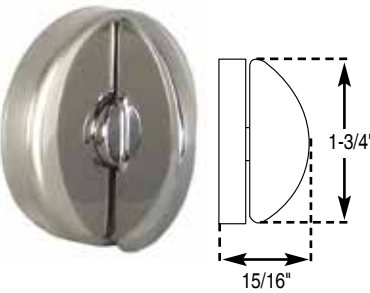

OPTION CODE T8

Base Metal: Stainless Steel

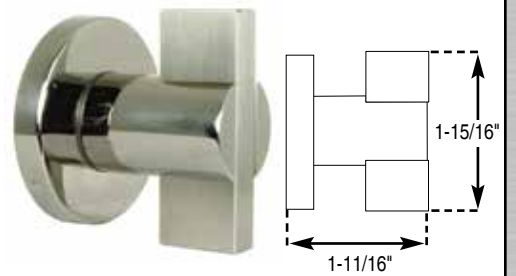

OPTION CODE T9

Base Metal: Stainless Steel

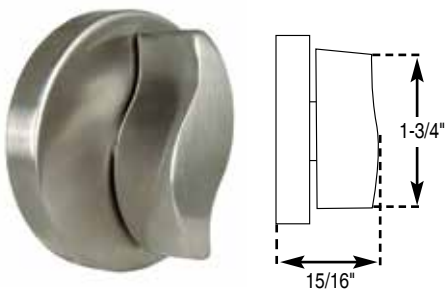

OPTION CODE T16

Base Metal: Stainless Steel

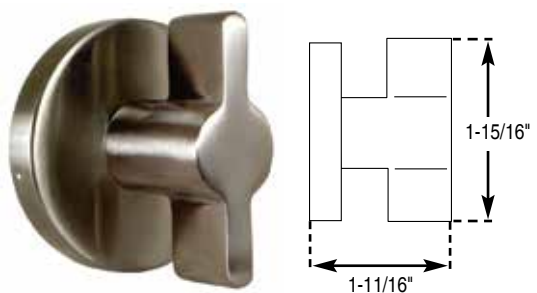

CUSTOM FORGED BRASS LEVERS

CUSTOM 1

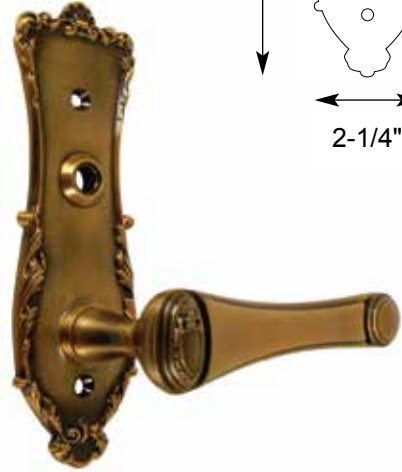
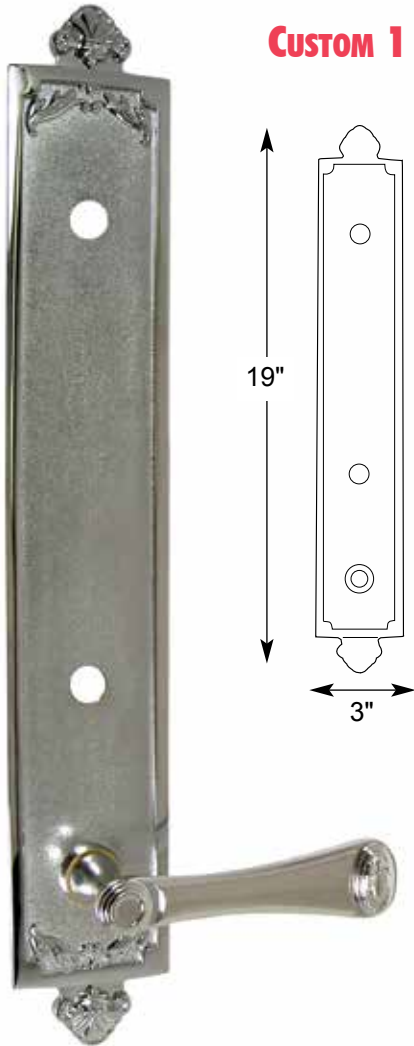

CUSTOM 2

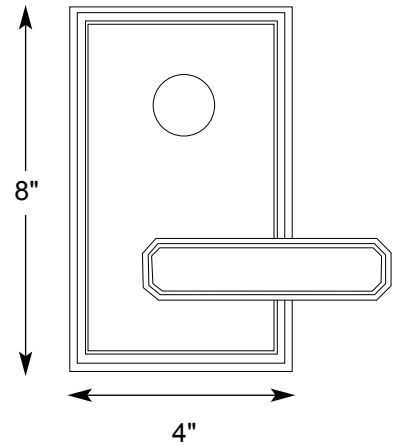

CUSTOM ESCUTCHEON PLATES

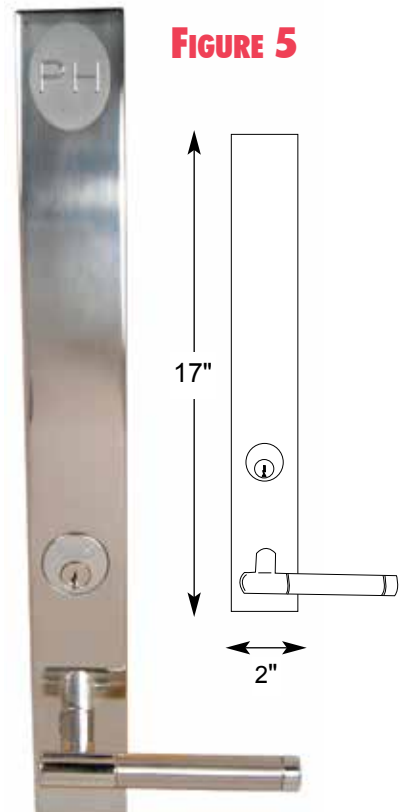
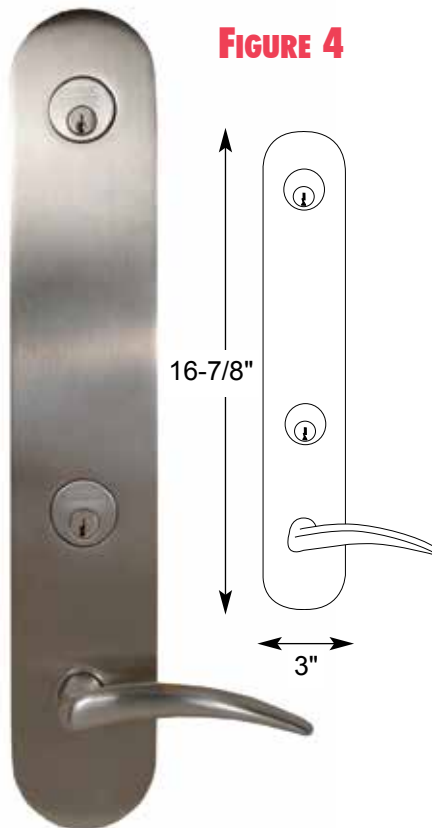
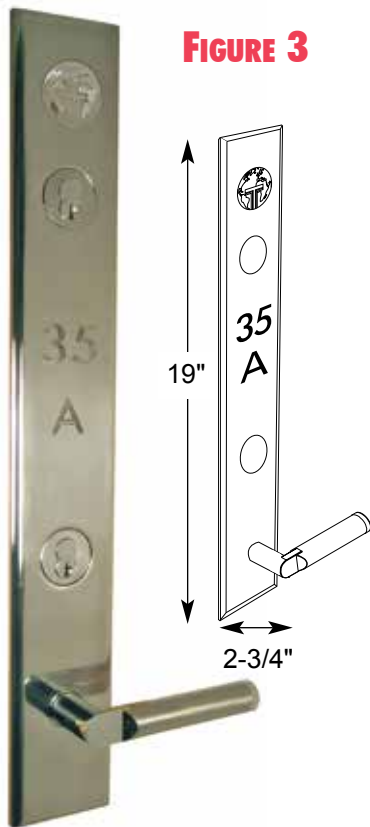
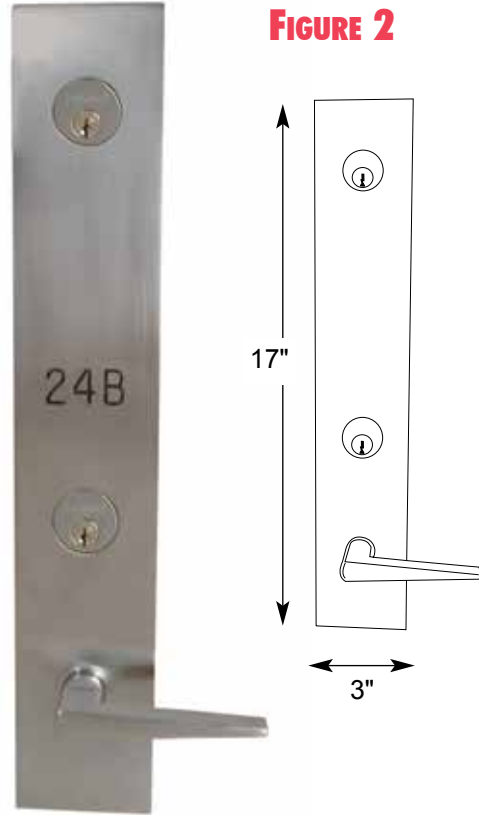
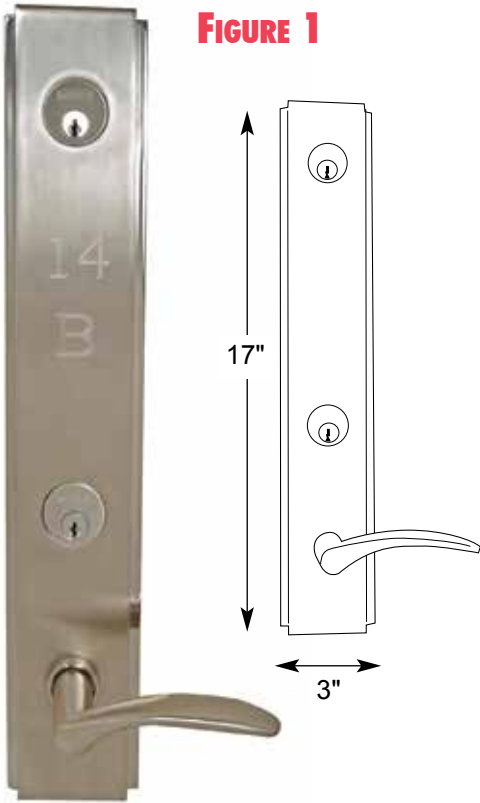

CUSTOM ESCUTCHEON PLATES

FIGURE 6

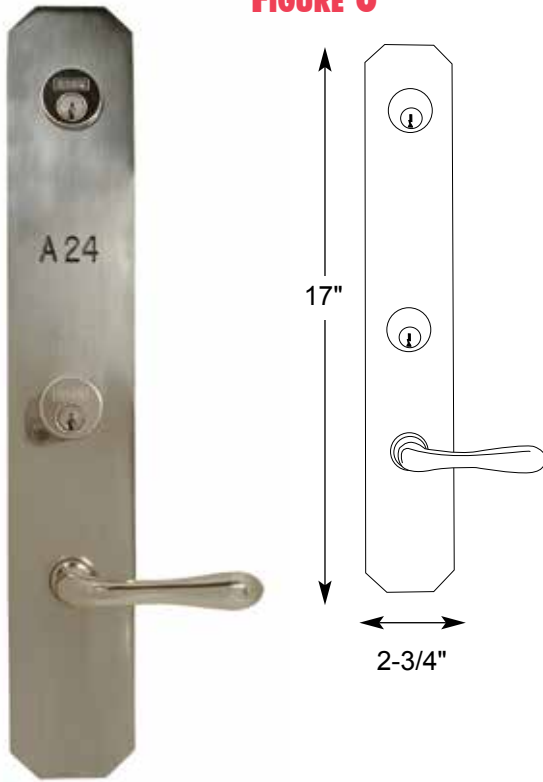

FIGURE 7

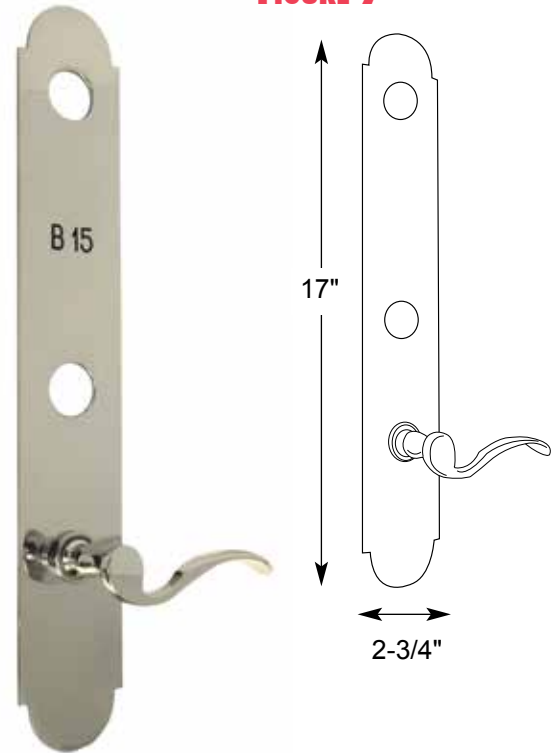

FIGURE 8

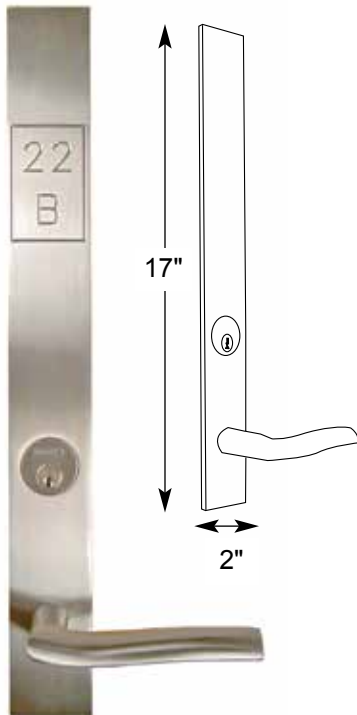

FIGURE 9

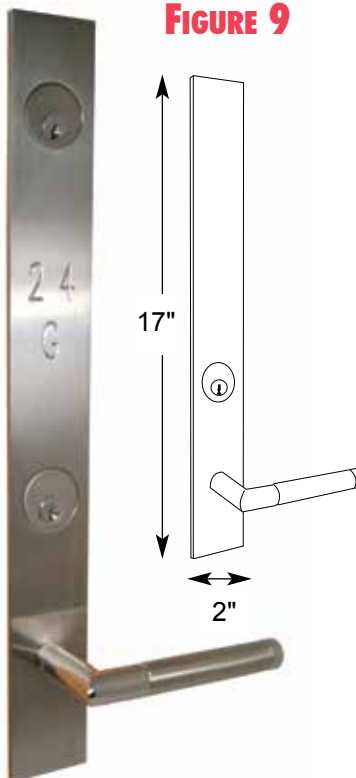
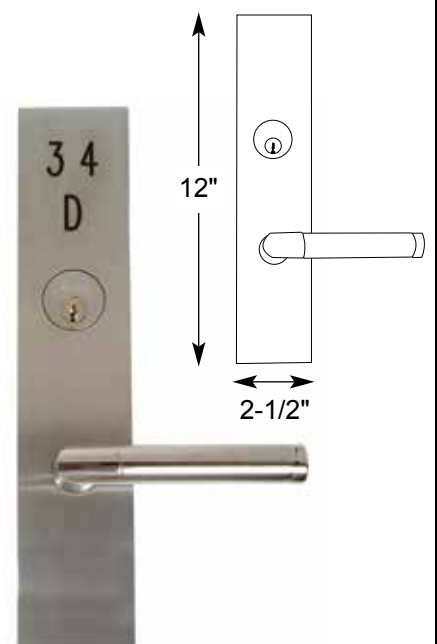

FIGURE 10



CUSTOM ESCUTCHEON PLATES

FIGURE 11

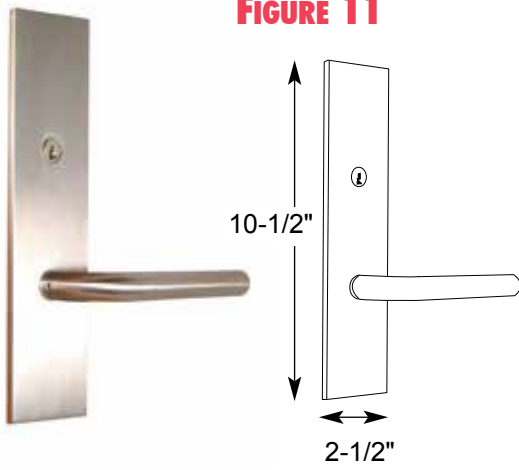

FIGURE 12

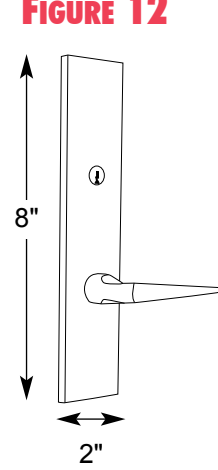

FIGURE 13

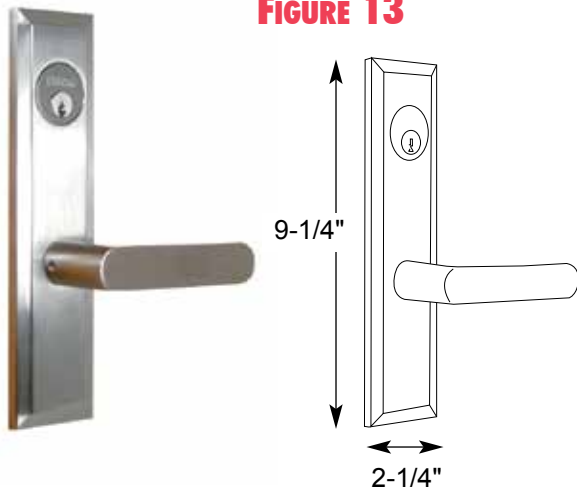

FIGURE 14

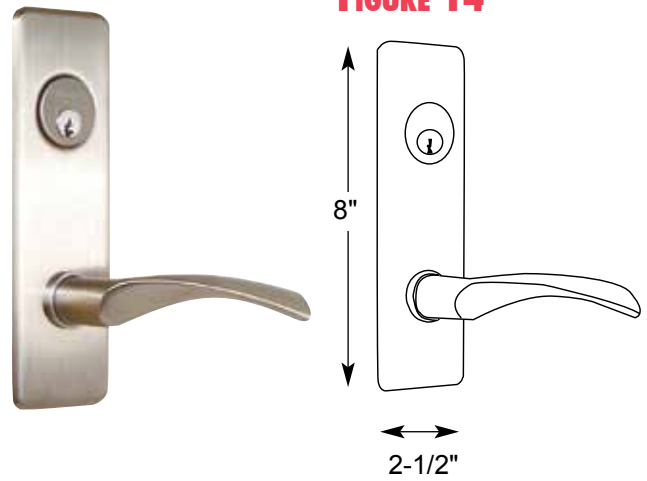

FIGURE 15

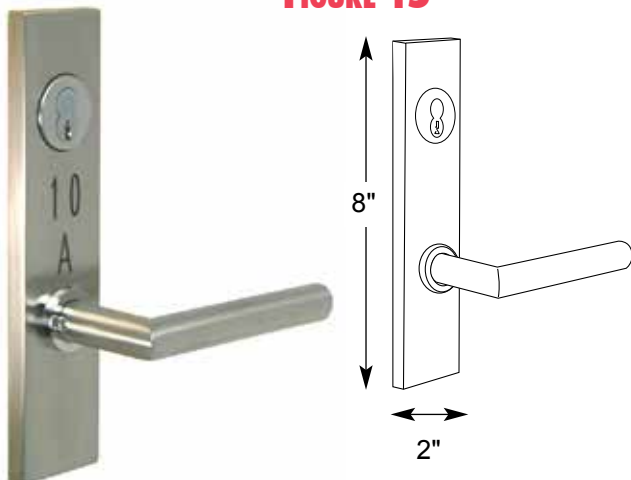
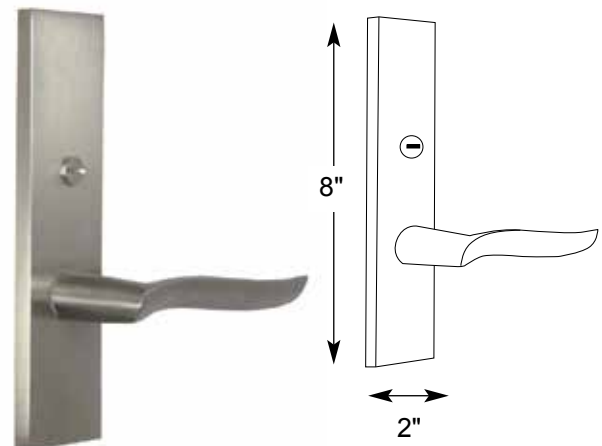
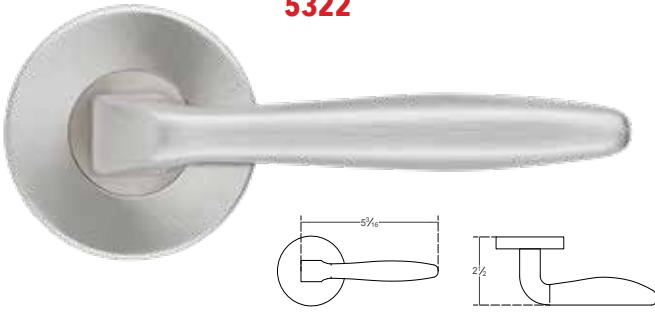

FIGURE 16



Additional Custom Designs

5322



5641

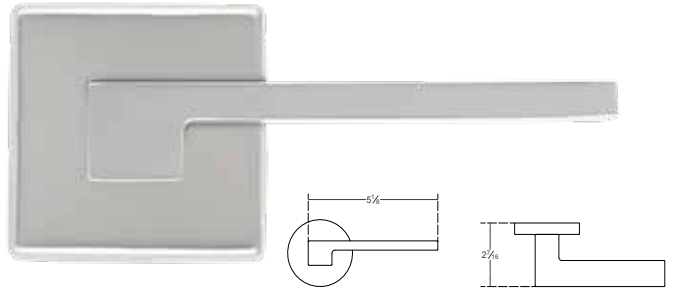

5637

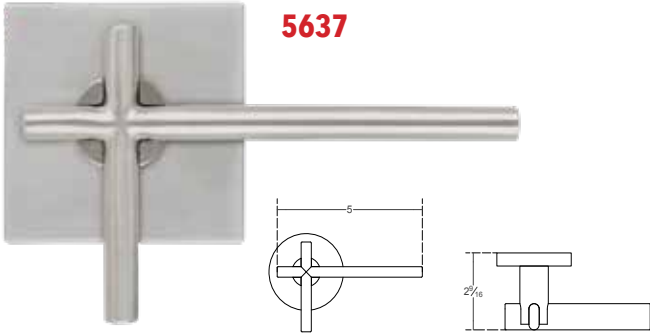

5647

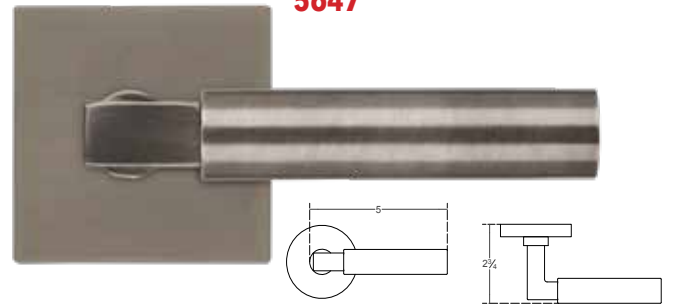

5691



5690

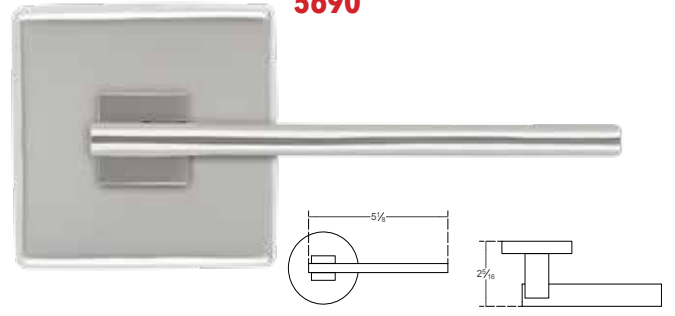

5679

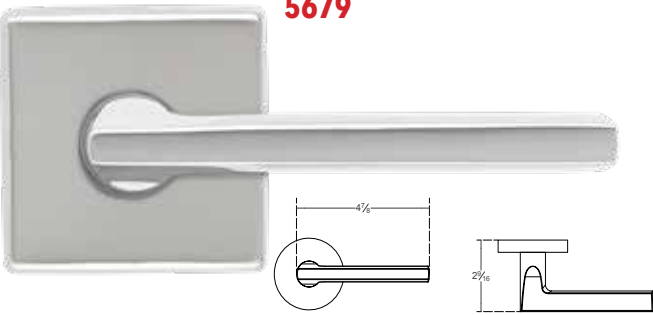

5697

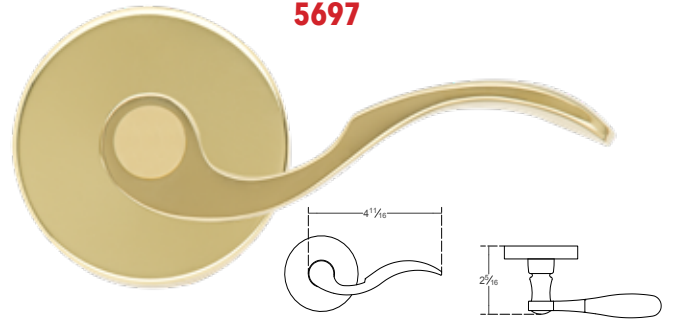

LH22

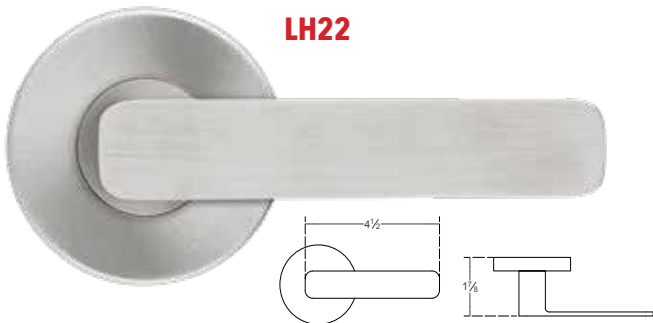

WS600



Additional Custom Designs

WP02

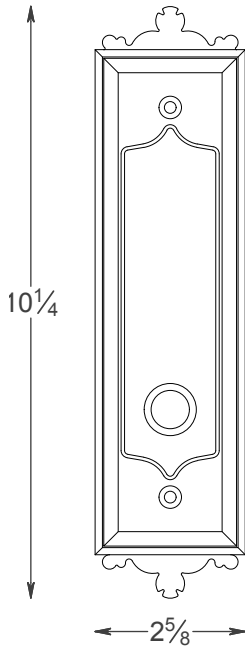
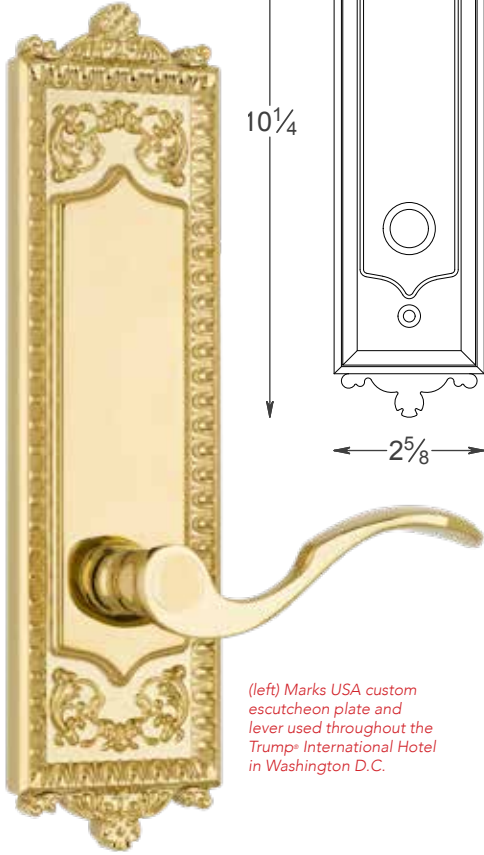

(left) Marks USA custom escutcheon plate and lever used throughout the Trump International Hotel in Washington D.C.

W04

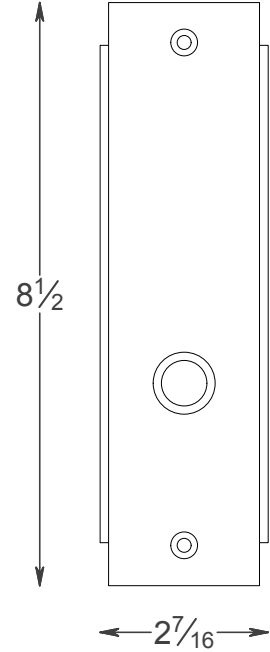

Option Code T15

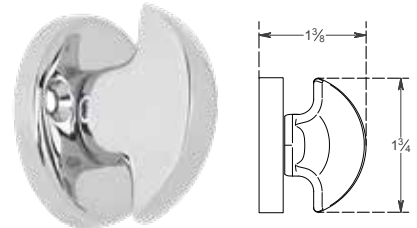

9633

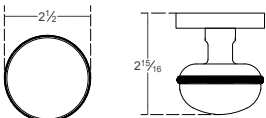

9691

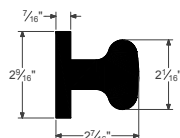

5697

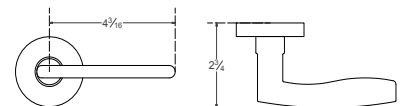

ArchiTech Designer Wireless Access Control

Standalone, Networked, or Enterprise



ArchiTech™ is the best of both worlds, combining infinite combinations of Marks Custom Lock, Grade 1 styles, hardware choices and architectural finishes, with sister Division Alarm Lock's Trilogy® Networx™ Lock Wireless Access Control electronics, class-leading for low-maintenance, longest battery life and breadth of line for every door type. Advanced electronics can be concealed within the door, or neatly on back, and are available in cylindrical, mortise, narrow stile and exit trim, matching in look and function, whether the application is standalone PIN/Prox or Multi-Technology ID Card access, networked and controlled from the server, or centrally-managed in realtime, including area-specific or global lockdown in seconds, with enterprise class software solutions with integrated platforms, including Continental CA4K®, Software House® or Lenel®. Easily networked for every building's construction, Architech Access Locks offer a choice of technologies, Ethernet, WiFi &/ or POE Gateways & Extenders, each controlling over 60 locks. And, for every access control client, from multi-dwelling residential to campus, and institutions or corporate security, these keyless access control locks, support a multi-user hierarchy for service staff, users and managers, as well as a vast variety of ID Credentials, including cards, fobs and mobile Smart App.

Plus, for coordinating the look for an entire building, Marks offers identical matching interior tubular locksets for passage, privacy and closets (dummy locksets). Visit Marks' www.designalock.com website and create, spec and share your own vision.

Standard Configurations

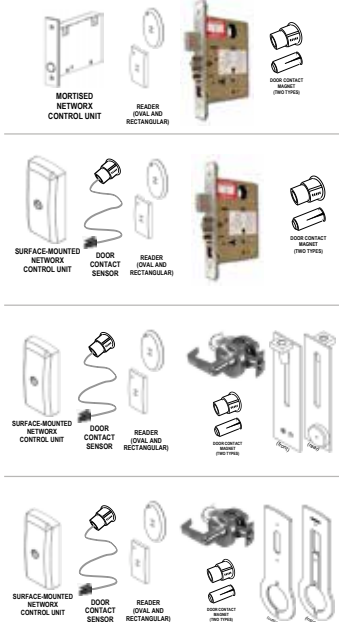

ArchiTech Networx Features:

- **All Applications and Doors** - Cylindrical and Mortise models for wood and metal doors, for new and existing applications, with wireless surface mount or mortised-in electronics and batteries. Surface-Mount or Mortised-in Electronics and Battery Pack
- **Customize To Match Any Aesthetic Look, For Every Décor** - Over 300 locks, levers, roses and finishes to choose from, durable ANSI/BHMA Grade 1 hardware. Over 300 locks, levers, roses and finishes available in mortise version.
- **Future-Proof Multi-Technology Access ID Credentials Replace Cumbersome Keys** – HID® Prox, Mag Stripe, Smart Cards, PIV, keyfobs, enabled iLock® App and remote buttons. 5000 Users, 500 Scheduled Events & 40,000 Event Audit Trail
- **Emergency Lock-Down** option via lock, button, keyfob or server (where networked). (Global Unlock via server too.)
- **Proven, Low Maintenance, Wireless Installation And Unsurpassed Battery-Life with Advanced Power-Saver circuit**, with years of use in even high-traffic areas, using off-the-shelf AA batteries, 3 year battery life, typ. using advanced Power-Saver circuit.
- **Auto-Deadbolt option** for automatic keyless locking of deadbolt upon exiting, ideal for residential applications
- **Flexible System Programming** Locally using a USB Gateway or remotely across a wireless network (using free Alarm Lock DL-WINDOWS Windows-based software) or integrated on an enterprise class IT environment, in realtime, using LENEL
- **Networking Choices** – Choose 802.11 or Ethernet network, with wireless encrypted bi-directional gateways, in which many locks communicate to a single gateway, expander, or use a wireless RF USB Gateway equivalent. For entry door applications and the like, used in conjunction with strikes and mags, use with Networx NetPanels. Or, use as a single-door control, in real time, as part of the IT-Network environment, with Continental Access CA4K®, Lenel OnGuard® Integrated Access Control & Video Security or Software House Connected Partner Program Platforms.‡



ArchiTech Designer Wireless Access Control

Standalone, Networked, or Enterprise



Networkx Gateways Options (no Panel or PIM required)

1 Networkx Gateway controls up to 63 wireless Networkx locks (repeaters also available for extending range).



Wired Gateway



POE Gateway



802.11 Gateway

Networkx Configuration Options (multi-technology ID card/credential readers available in multiple shapes & colors)



Concealed electronics

Mortised-in electronics and batteries

Cylindrical; Surface Mounted Electronics (back box not shown)

Mortise; Surface Mounted Electronics

Mag Stripe Reader

Keypad

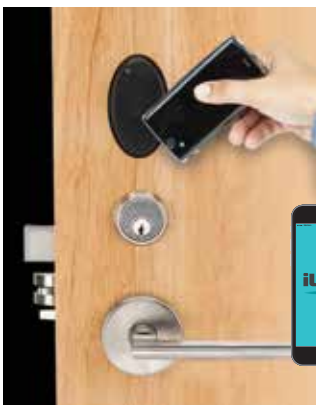

The Key is Your Smartphone & More Secure Technology: Use the iLock® App to unlock your Networkx ArchiTech™ Bluetooth® Series Door Lock in seconds!

iLock, the easy smartphone mobile solution for unlocking your Trilogy® ArchiTech Bluetooth Series Designer Access Control Locks from up to 30 feet away with any smart device, without the need to carry cumbersome ID cards or keys. Password protected access is secure through the use of Bluetooth LE® and proprietary encryption. For even greater security users can add an optional passcode, entered on their phone App.

Coming soon: emailable digital eKeys for guests or service temporary access, too.

iLock App is available from both iTunes and the Google Play Store



Style MARKS



Create your own custom lock looks

www.designalock.com

Create, spec & share a custom lock vision for any space or building with www.designalock.com interactive site for trying out various lock looks for locks inside and out. Ideal for Architects, Designers and Building Operating Management who want their access control and locking "look" to be as welcome as the security they provide.

ABOUT US: MARKS USA was established in 1977 to serve a growing demand for a mortise lock manufacturing company who would satisfy the needs of an expanding market. Since then, the product line has grown to include residential and commercial locksets to meet and exceed the most stringent UL and BHMA/ANSI specifications. In 1989, the *Custom Lockset Division* was created to accommodate customers with special requirements of either lock function or design. Custom locksets have been developed for numerous municipal and commercial applications, including those shown.. These are various custom locksets developed to accommodate our customers needs. This is only a sampling of our solutions. We at the *Custom Lockset Division* welcome the opportunity to respond to special applications requiring a custom engineered lock product. Marks USA makes compliance with the Buy American Act (BAA) and American Recovery & Reinvestment Act (ARRA) easy, as an American manufacturer of quality door hardware products with manufacturing facilities in Long Island, NY.



MARKS USA



365 Bayview Ave. • Amityville, NY 11701 • USA • 800-645-9445 • Fax: 631-225-6136
salesinfo@marksusa.com • www.marksusa.com

Marks USA is a Division of NAPCO Security Technologies, Inc. (NASDAQ:NSSC) • NAPCO • Alarm Lock • Continental Access • Marks USA

ArchiTech, Trilogy, Network and iLock are trademarks of NAPCO Security. Other trademarks listed are properties of their respective companies. Lifetime warranty limited to mechanical lock (excluding finish). See full details Pg 1 &/or at www.marksusa.com

©Marks USA, 2020