

# ALARM LOCK

## Price Book 2025-2026 Effective July 15, 2025 Updated December 1, 2025

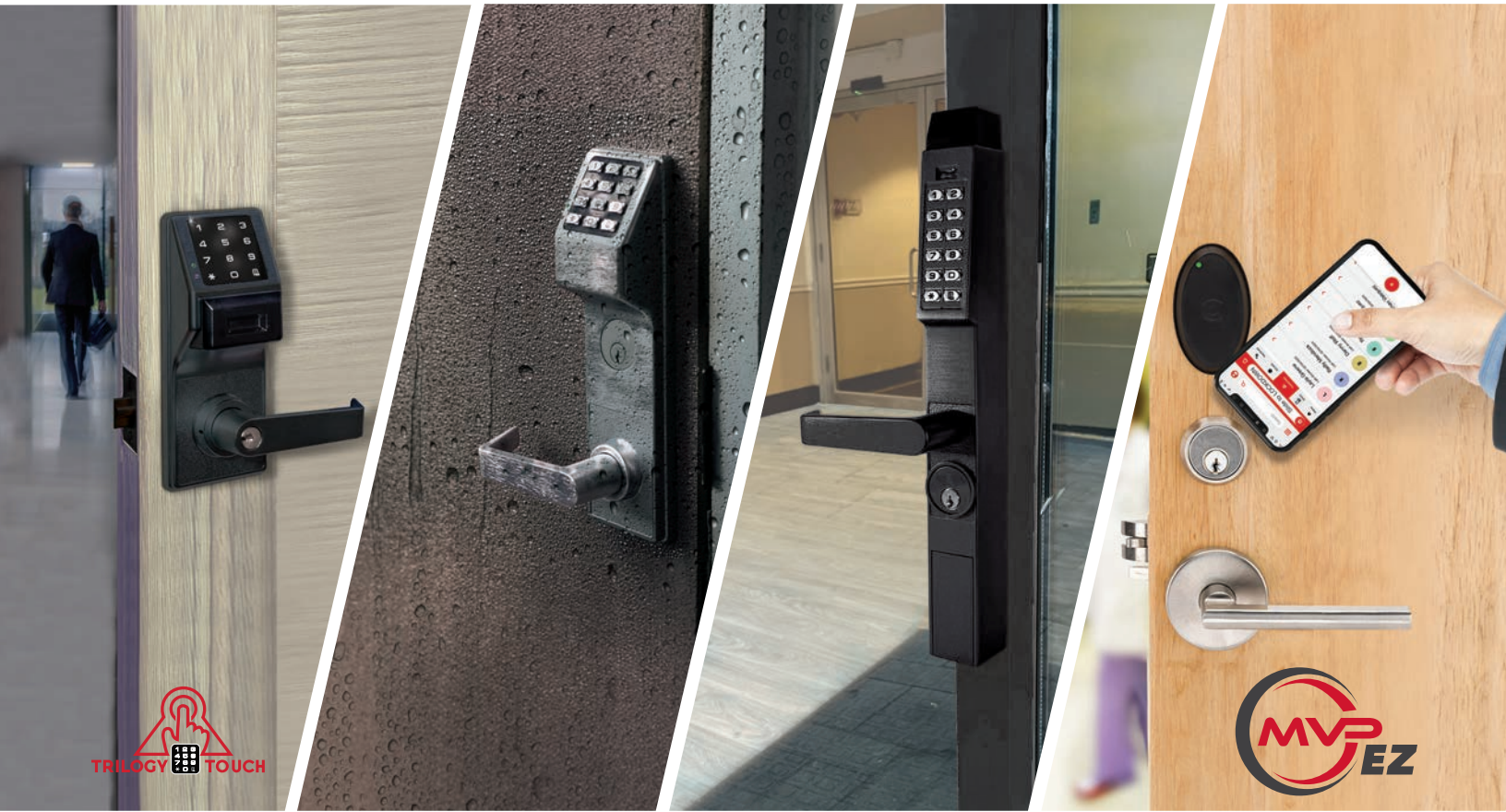

**#1 Rated Alarm Lock Trilogy Keyless Standalone & Wireless Network Access Networked Lock Solutions**





**Trilogy Locks**

- DL2700 Series ..... 3
- DL5200 Series ..... 5
- DL2700CR/DB Series ..... 5
- DL3200 Series ..... 6
- DL5300 Series ..... 7
- DL4100 Series ..... 8
- PDL3000 Series ..... 9
- PDL5300 Series ..... 10
- PDL4100 Series ..... 11
- DL3500 Series ..... 13
- DL4500 Series ..... 14
- PDL3500/PL3500 Series ..... 15
- PDL4500 Series ..... 16
- DL1200 Series ..... 17
- DL1300 Series ..... 18
- PDL1300 Series ..... 19
- DL1200ET, DL1300ET & PDL1300ET Series ..... 20
- TRILOGY EXIT TRIM PRODUCTS ..... 22
- HOW TO ORDER YOUR TRILOGY EXIT LOCK ..... 25
- DK3000/PDK3000 Series ..... 26

**Network Locks**

- DL6100 Series ..... 27
- PDL6200 Series ..... 28
- PL6200 Series ..... 29
- PDL6600 Series ..... 32
- PDL/PL8200 Series ..... 34
- PDL8600 Series ..... 36
- TRILOGY NETWORKX EXIT TRIM Series ..... 37
- HOW TO ORDER YOUR TRILOGY NETWORKX EXIT LOCK ..... 42
- TRILOGY NETWORKX WIRELESS KEYPADS AND NETPANEL ..... 43
- PDL6300 Series ..... 44
- PDL1300NW Series ..... 45
- PDLN4100 Series ..... 46
- PDLN4500 Series ..... 47
- Trilogy Network Accessories ..... 47

**Trilogy Accessories**

- Accessories ..... 48

**ArchiTech**

- ArchiTech Series Network Locks ..... 52
- ArchiTech Series Cylindrical Locks ..... 56
- ArchiTech Series Mortise Locks ..... 57
- HOW TO ORDER ARCHITECH MORTISE MODELS ..... 58
- ArchiTech Series Network Locks Parts & Accessories ..... 59

**Panic Egress + Accessories**

- WEATHER-RESISTANT ARMED PANIC LOCKS - Models 250, 260, 700, 710 ..... 60
- Door Alarm - PG10, PG21 & PG30 SERIES ..... 60
- DELAYED EGRESS PANIC LOCKS ..... 61
- Accessories ..... 61

**Air Access, E-Access**

- Air Access, E-Access ..... 62

**MVP Access, MVP EZ & NA-Series Access Control Panels**

- PROX Readers ..... 63
- Credentials ..... 63
- Coming Soon: MVP EZ ..... 64
- MVP Access & MVP EZ App-/Cloud-Based Platform & Select Available Hardware Options ..... 65
- Select Popular Door Hardware Options for Use with MVP Platform ..... 65
- MVP: 4 EZ Steps! ..... 66

**Warranty/Return Policy**

- Warranty/Return Policy ..... 67

## DL2700 Series

Grade 1, standalone electronic keypad lock designed for commercial and institutional applications, including schools, healthcare facilities, offices, and retail environments. Part of the Trilogy T2 series, it offers robust security features, user-friendly programming, and versatile installation options

- Door Thickness:** Fits 1 5/8" to 1 7/8".
- Backset:** 2 3/4" (2 3/8" also available. Must Specify When Ordering)
- Strike:** 1 1/8"x 2 3/4" T strike & 1 1/4" x 4 7/8 ASA strike included
- Latchbolt:** UL Listed, fire rated 3 hours, 1/2" throw reversible
- Handing:** Non-handed
- Power:** 5 AA alkaline batteries (included)
- Keypad:** All metal, 12 button. All functions programmed through keypad.
- Compliances:** BHMA Certified Grade 1 heavy duty cylindrical lockset. UL listed UL Listed 10C Positive Pressure Specification. ADA compliant levers
- Cylinder:** 6 pin solid brass, SC1 keyway, furnished with all key override locks. Schlage, Corbin-Russwin CL, Sargent 480 series, ASSA 65-611 & Lori cylinders can also be used with HW620 tailpiece (supplied)



Part No.	Special Features	Finish	Prep	List Price
DL2700/10B	Standard key override	10B	Standard ANSI A115 Series prep	\$1,669.56
	<b>Users:</b> 100 user codes, - 1 Master, 10 Manager			
DL2700/19	Standard key override	19	Standard ANSI A115 Series prep	\$1,043.29
	<b>Users:</b> 100 user codes, - 1 Master, 10 Manager			
DL2700/26D	Standard key override	26D	Standard ANSI A115 Series prep	\$1,043.29
	<b>Users:</b> 100 user codes, - 1 Master, 10 Manager			
DL2775/26D	Standard key override w/ Regal Lever	26D	Standard ANSI A115 Series prep	\$1,111.65
	<b>Users:</b> 100 user codes, - 1 Master, 10 Manager			
DL2700IC/26D	IC Core	10B	Standard ANSI A115 Series prep	\$1,085.19
	<b>Users:</b> 100 user codes, - 1 Master, 10 Manager			
DL2700IC/19	IC Core	19	Standard ANSI A115 Series prep	\$1,085.19
	<b>Users:</b> 100 user codes, - 1 Master, 10 Manager			
DL2700IC/10B	IC Core	10B	Standard ANSI A115 Series prep	\$1,847.35
	<b>Users:</b> 100 user codes, - 1 Master, 10 Manager			
DL2700IC/26D-C	Corbin IC Core	26D	Standard ANSI A115 Series prep	\$1,540.49
	<b>Users:</b> 100 user codes, - 1 Master, 10 Manager			
DL2700IC/26D-R	Sargent IC Core	26D	Standard ANSI A115 Series prep	\$1,540.49
	<b>Users:</b> 100 user codes, - 1 Master, 10 Manager			
DL2700IC/26D-S	Schlage IC Core	26D	Standard ANSI A115 Series prep	\$1,540.49
	<b>Users:</b> 100 user codes, - 1 Master, 10 Manager			
DL2700IC7/26D-C	Corbin 7 pin IC Core	26D	Standard ANSI A115 Series prep	\$1,540.49
	<b>Users:</b> 100 user codes, - 1 Master, 10 Manager			



### DL2700 Series (continue)



Part No.	Special Features	Finish	Prep	List Price
DL2700IC7/26D-Y	Yale 7 pin IC Core	26D	Standard ANSI A115 Series prep	\$1,540.49
	<b>Users:</b> 100 user codes, - 1 Master, 10 Manager			
DL2700IC/26D-M	Medeco IC Core	26D	Standard ANSI A115 Series prep	\$1,540.50
	<b>Users:</b> 100 user codes, - 1 Master, 10 Manager			
DL2700IC/10B-C	Corbin IC Core	10B	Standard ANSI A115 Series prep	\$1,868.03
	<b>Users:</b> 100 user codes, - 1 Master, 10 Manager			
DL2700IC/10B-M	Medeco IC Core	10B	Standard ANSI A115 Series prep	\$1,868.03
	<b>Users:</b> 100 user codes, - 1 Master, 10 Manager			
DL2700IC/10B-R	Sargent IC Core	10B	Standard ANSI A115 Series prep	\$1,868.03
	<b>Users:</b> 100 user codes, - 1 Master, 10 Manager			
DL2700IC/10B-S	Schlage IC Core	10B	Standard ANSI A115 Series prep	\$1,868.03
	<b>Users:</b> 100 user codes, - 1 Master, 10 Manager			
DL2700IC/10B-Y	Yale IC Core	10B	Standard ANSI A115 Series prep	\$1,868.03
	<b>Users:</b> 100 user codes, - 1 Master, 10 Manager			
DL2700LD/26D	Locdown Series, Standar Key Override	26D	Standard ANSI A115 Series prep	\$1,085.19
	<b>Users:</b> 100 user codes, - 1 Master, 10 Manager			
DL2700LDIC/26D	Locdown Series, Standar Key Override, IC Core	26D	Standard ANSI A115 Series prep	\$1,127.09
	<b>Users:</b> 100 user codes, - 1 Master, 10 Manager			
DL2700LDIC26D-S	Locdown Series, Schlage IC Core	26D	Standard ANSI A115 Series prep	\$1,608.96
	<b>Users:</b> 100 user codes, - 1 Master, 10 Manager			
DL2775IC/26D-S	Regal (curved), Schlage IC Core	26D	Standard ANSI A115 Series prep	\$1,638.91
	<b>Users:</b> 100 user codes, - 1 Master, 10 Manager			
TL2700/26D	Touch Sense Panel w/ Illuminating Numbers	26D	Standard ANSI A115 Series prep	\$1,043.29
	<b>Users:</b> 100 user codes, - 1 Master, 10 Manager			

## DL5200 Series

Double sided electronic battery operated digital lock that Incorporates all of the important features of the most-popular Trilogy DL2700

- Door Thickness:** Fits 1 5/8" to 1 7/8".
- Backset:** 2 3/4" (2 3/8" also available. Must Specify when ordering)
- Strike:** 1 1/8" x 2 3/4" T strike & 1 1/4" x 4 7/8" ASA strike included
- Latchbolt:** UL Listed, fire rated 3 hours, 1/2" throw reversible
- Handing:** Non-handed
- Power:** 5 AA alkaline batteries (included)
- Keypad:** All metal, 12 button. All functions programmed through keypad on both sides of the door
- Compliances:** BHMA Certified Grade 1 heavy duty cylindrical lockset. UL listed UL Listed 10C Positive Pressure Specification. ADA compliant levers
- Cylinder:** 6 pin solid brass, SC1 keyway, furnished with all key override locks. Schlage, Corbin-Russwin CL, Sargent 480 series, ASSA 65-611 & Lori cylinders can also be used with HW620 tailpiece (supplied)

Part No.	Special Features	Finish	Prep	List Price
DL5200/26D	Standard Key Override	26D	Standard ANSI A115 Series prep	\$2,580.03
	<b>Users:</b> 100 user codes, 1 Master, 10 Manager codes & up to 3 one time user codes			
DL5200IC/26D	IC Core	26D	Standard ANSI A115 Series prep	\$2,619.99
	<b>Users:</b> 100 user codes, 1 Master, 10 Manager codes & up to 3 one time user codes			

## DL2700CR/DB Series

Trilogy T2 Keyless Access Lock designed for mortise door prep, you have the opportunity to choose from various classroom or deadbolt functions. Each function offers distinct security features tailored to meet specific access needs.

- Door Thickness:** Fits 1 3/8" to 1 7/8" (4.46cm). Backset:
- Strike:** 1 1/4" x 4 7/8" strike included
- Handing:** Specify RH or LH when ordering, lock is reversible in the field
- Power:** 5 AA batteries (included)
- Keypad:** All metal, 12 button. Basic functions programmed through keypad.
- Door prep:** Standard ANSI A115 Mortise prep, modified by adding additional through-bolt holes
- Compliances:** Steelcase lock body meets BHMA specifications For Grade 1 locks. UL listed to the 10C Positive Pressure Specification. FCC Certified. ADA compliant levers
- Functions:** Classroom function feature stainless steel latchbolt with 3/4" (1.91cm) projection & deadlocking latch Deadbolt function feature stainless steel deadbolt with 1" (2.55cm) projection, latchbolt with 3/4" (1.91cm) projection & deadlocking latch Deadbolt may be projected from key cylinder from outside door or turn-piece from inside door.
- Cylinder:** 1 3/8" (3.5cm) mortise cylinder supplied. Will accept 1 3/8" to 1 1/2" (3.5 - 3.82cm) mortise Cylinder.
- Cams:** Classroom function supplied with straight cam. Deadbolt Supplied with cloverleaf Cam.

Part No.	Special Features	Finish	Prep	List Price
DL2700CRL/26D	Straight lever classroom, Function left hand	26D	Standard ANSI A115 Mortise prep	\$1,744.35
	<b>Users:</b> Holds up to 100 use codes, 1 master, 10 manager codes & up to 3 one time user codes.			
DL2700CRR/26D	Straight lever classroom, Function right hand	26D	Standard ANSI A115 Mortise prep	\$1,744.35
	<b>Users:</b> Holds up to 100 use codes, 1 master, 10 manager codes & up to 3 one time user codes.			
DL2700DBL/26D	Straight lever deadbolt, Function left hand	26D	Standard ANSI A115 Mortise prep	\$1,744.35
	<b>Users:</b> Holds up to 100 use codes, 1 master, 10 manager codes & up to 3 one time user codes.			
DL2700DBR/26D	Straight lever deadbolt, Function right hand	26D	Standard ANSI A115 Mortise prep	\$1,744.35
	<b>Users:</b> Holds up to 100 use codes, 1 master, 10 manager codes & up to 3 one time user codes.			



## DL3200 Series

Grade 1 electronic cylindrical lockset offering audit trail, timed scheduling, and PIN code access, suitable for commercial, institutional, and high-security applications with more robust access control features.

**Door Thickness: Fits 1 5/8" to 1 7/8".**

<b>Backset:</b>	2 3/4" (2 3/8" also available)
<b>Strike:</b>	1 1/8" x 2 3/4" T strike & 1 1/4" x 4 7/8" ASA strike included
<b>Latchbolt:</b>	UL Listed, fire rated 3 hours, 1/2" throw reversible
<b>Handing:</b>	Non-handed
<b>Power:</b>	5 AA alkaline batteries (included)
<b>Keypad:</b>	All metal, 12 button. All functions programmed through keypad.
<b>Compliances:</b>	BHMA Certified Grade 1 heavy duty cylindrical lockset. UL listed 10C Positive Pressure Specification. ADA-compliant levers
<b>Cylinder:</b>	6 pin solid brass, SC1 keyway, furnished with all key override locks. Schlage, Corbin-Russwin CL, Sargent 480 series, ASSA 65-611 & Lori cylinders can also be used with HW620 tailpiece (supplied)
<b>Interchangeable Core Models:</b>	Standard model accepts 6 & 7 pin cylinders from Best, Falcon, Arrow, KSP, Medeco Keymark & Kaba Peaks. IC core models prepped for 6 & 7 pin Yale, Medeco, Sargent, Corbin-Russwin & Schlage are also available



Part No.	Special Features	Finish	Prep	List Price
DL3200/10B	Standard key override	10B	Standard ANSI A115 Series prep	\$1,770.90
	<b>Users:</b> Holds up to 2,000 codes, Master, Management, Supervisor & basic user. 500 event schedule, multiple "one-time" user codes & 40,000 event audit trail			
DL3200/26D	Standard key override	26D	Standard ANSI A115 Series prep	\$1,662.36
	<b>Users:</b> Holds up to 2,000 codes, Master, Management, Supervisor & basic user. 500 event schedule, multiple "one-time" user codes & 40,000 event audit trail			
DL3200IC/10B	IC Core	10B	Standard ANSI A115 Series prep	\$1,814.32
	<b>Users:</b> Holds up to 2,000 codes, Master, Management, Supervisor & basic user. 500 event schedule, multiple "one-time" user codes & 40,000 event audit trail			
DL3200IC/10B-C	Corbin Russwin IC Core	10B	Standard ANSI A115 Series prep	\$1,836.02
	<b>Users:</b> Holds up to 2,000 codes, Master, Management, Supervisor & basic user. 500 event schedule, multiple "one-time" user codes & 40,000 event audit trail			
DL3200IC/10B-M	Medeco IC Core	10B	Standard ANSI A115 Series prep	\$1,836.02
	<b>Users:</b> Holds up to 2,000 codes, Master, Management, Supervisor & basic user. 500 event schedule, multiple "one-time" user codes & 40,000 event audit trail			
DL3200IC/10B-R	Sargent IC Core	10B	Standard ANSI A115 Series prep	\$1,836.02
	<b>Users:</b> Holds up to 2,000 codes, Master, Management, Supervisor & basic user. 500 event schedule, multiple "one-time" user codes & 40,000 event audit trail			
DL3200IC/10B-Y	Yale IC Core	10B	Standard ANSI A115 Series prep	\$1,836.02
	<b>Users:</b> Holds up to 2,000 codes, Master, Management, Supervisor & basic user. 500 event schedule, multiple "one-time" user codes & 40,000 event audit trail			
DL3200IC/26D	IC Core	26D	Standard ANSI A115 Series prep	\$1,705.77
	<b>Users:</b> Holds up to 2,000 codes, Master, Management, Supervisor & basic user. 500 event schedule, multiple "one-time" user codes & 40,000 event audit trail			
DL3200IC/26D-C	Corbin Russwin IC Core	26D	Standard ANSI A115 Series prep	\$1,727.48
	<b>Users:</b> Holds up to 2,000 codes, Master, Management, Supervisor & basic user. 500 event schedule, multiple "one-time" user codes & 40,000 event audit trail			

## DL3200 Series (continue)



Part No.	Special Features	Finish	Prep	List Price
DL3200IC/26D-M	Medeco IC Core <b>Users:</b> Holds up to 2,000 codes, Master, Management, Supervisor & basic user. 500 event schedule, multiple "one-time" user codes & 40,000 event audit trail	26D	Standard ANSI A115 Series prep	\$1,727.48
DL3200IC/26D-Y	Yale IC Core <b>Users:</b> Holds up to 2,000 codes, Master, Management, Supervisor & basic user. 500 event schedule, multiple "one-time" user codes & 40,000 event audit trail	26D	Standard ANSI A115 Series prep	\$1,727.48
DL3200IC/26D-S	Schlage IC Core <b>Users:</b> Holds up to 2,000 codes, Master, Management, Supervisor & basic user. 500 event schedule, multiple "one-time" user codes & 40,000 event audit trail	26D	Standard ANSI A115 Series prep	\$1,727.48
DL3200IC/26D-Y	Yale IC Core <b>Users:</b> Holds up to 2,000 codes, Master, Management, Supervisor & basic user. 500 event schedule, multiple "one-time" user codes & 40,000 event audit trail	26D	Standard ANSI A115 Series prep	\$1,727.48
DL3200IC7/26D-C	Corbin Russwin IC Core 7pin <b>Users:</b> Holds up to 2,000 codes, Master, Management, Supervisor & basic user. 500 event schedule, multiple "one-time" user codes & 40,000 event audit trail	26D	Standard ANSI A115 Series prep	\$1,727.48
DL3200IC7/26D-Y	Yale IC 7pin <b>Users:</b> Holds up to 2,000 codes, Master, Management, Supervisor & basic user. 500 event schedule, multiple "one-time" user codes & 40,000 event audit trail	26D	Standard ANSI A115 Series prep	\$1,727.48

## DL5300 Series

Double sided electronic battery operated digital lock. Only primary keypad has data transfer capability. Key override is only operable on the primary side. The key on the secondary side is used only to remove the lever and access the batteries.

- Door Thickness:** Fits 1 5/8" to 1 7/8". Other thickness,  
**Backset:** 2 3/4" (2 3/8" also available)  
**Strike:** 1 1/8"x 2 3/4" T strike & 1 1/4" x 4 7/8" ASA strike included  
**Latchbolt:** UL Listed, fire rated 3 hours, 1/2" throw reversible  
**Handing:** Non-handed  
**Power:** 5 AA alkaline batteries (included)  
**Keypad:** All metal, 12 button.  
**Compliances:** BHMA Certified Grade 1 heavy duty cylindrical lockset. UL listed 10C Positive Pressure Specification. ADA compliant levers  
**Cylinder:** 6 pin solid brass, SC1 keyway, furnished with all key override locks. Schlage, Corbin-Russwin CL, Sargent 480 series, ASSA 65-611 & Lori cylinders can also be used with HW620 tailpiece (supplied)



Part No.	Special Features	Finish	Prep	List Price
DL5300/26D	Standard Key override <b>Users:</b> Holds up to 2,000 codes, Master, Management, Supervisor & basic user. 500 event schedule, multiple "one-time" user codes & 40,000 event audit trail	26D	Standard ANSI A115 Series prep	\$2,989.93
DL5300IC/10B	IC Core <b>Users:</b> Holds up to 2,000 codes, Master, Management, Supervisor & basic user. 500 event schedule, multiple "one-time" user codes & 40,000 event audit trail	10B	Standard ANSI A115 Series prep	\$3,157.91
DL5300IC/26D	IC Core <b>Users:</b> Holds up to 2,000 codes, Master, Management, Supervisor & basic user. 500 event schedule, multiple "one-time" user codes & 40,000 event audit trail	26D	Standard ANSI A115 Series prep	\$2,997.93

## DL4100 Series

Electronic battery operated digital lock. Privacy feature will lock out all basic users for programmable amount of time. Residency feature-allows exiting without having to lock the door.



- Door Thickness:** Fits 1 5/8" to 1 7/8".
- Backset:** 2 3/4" (2 3/8" also available)
- Strike:** 1 1/8"x 2 3/4" T strike & 1 1/4" x 4 7/8" ASA strike included
- Latchbolt:** UL Listed, fire rated 3 hours, 1/2" throw reversible
- Handing:** Non-handed
- Power:** 5 AA alkaline batteries (included)
- Keypad:** All metal, 12 button. All functions programmed through keypad.
- Compliances:** BHMA Certified Grade 1 heavy duty cylindrical lockset. UL listed 10C Positive Pressure Specification. ADA compliant levers
- Cylinder:** 6 pin solid brass, SC1 keyway, furnished with all key override locks. Schlage, Corbin-Russwin CL, Sargent 480 series, ASSA 65-611 & Lori cylinders can also be used with HW620 tailpiece (supplied)
- Interchangeable Core Models:** Standard model accepts 6 & 7 pin cylinders from Arrow, KSP, Medeco Keymark & Kaba Peaks. IC core models prepped for 6 & 7 pin Yale, Medeco, Sargent, Corbin-Russwin & Schlage are also available

Part No.	Special Features	Finish	Prep	List Price
DL4100/26D	Standard Key override	26D	Standard ANSI A115 Series prep	\$1,641.34
	<b>Users:</b> Holds up to 2000 codes, Master, Management, Supervisor & basic user. Multiple "one-time" user codes. 500 event schedule, real time clock & 40,000 event audit trail			
DL4100IC/26D	IC Core	26D	Standard ANSI A115 Series prep	\$1,679.73
	<b>Users:</b> Holds up to 2000 codes, Master, Management, Supervisor & basic user. Multiple "one-time" user codes. 500 event schedule, real time clock & 40,000 event audit trail			
DL4100IC/26D-S	Schlage IC Core	26D	Standard ANSI A115 Series prep	\$1,702.52
	<b>Users:</b> Holds up to 2000 codes, Master, Management, Supervisor & basic user. Multiple "one-time" user codes. 500 event schedule, real time clock & 40,000 event audit trail			
DL4100IC/26D-C	Corbin Russwin IC Core	26D	Standard ANSI A115 Series prep	\$1,702.52
	<b>Users:</b> Holds up to 2000 codes, Master, Management, Supervisor & basic user. Multiple "one-time" user codes. 500 event schedule, real time clock & 40,000 event audit trail			
DL4100IC/26D-Y	Yale IC Core	26D	Standard ANSI A115 Series prep	\$1,702.52
	<b>Users:</b> Holds up to 2000 codes, Master, Management, Supervisor & basic user. Multiple "one-time" user codes. 500 event schedule, real time clock & 40,000 event audit trail			
DL4100IC/26D-R	Sargent IC Core	26D	Standard ANSI A115 Series prep	\$1,702.52
	<b>Users:</b> Holds up to 2000 codes, Master, Management, Supervisor & basic user. Multiple "one-time" user codes. 500 event schedule, real time clock & 40,000 event audit trail			
DL4100/10B	Standard Key override	10B	Standard ANSI A115 Series prep	\$1,747.71
	<b>Users:</b> Holds up to 2000 codes, Master, Management, Supervisor & basic user. Multiple "one-time" user codes. 500 event schedule, real time clock & 40,000 event audit trail			
DL4100IC/10B	IC Core	10B	Standard ANSI A115 Series prep	\$1,784.18
	<b>Users:</b> Holds up to 2000 codes, Master, Management, Supervisor & basic user. Multiple "one-time" user codes. 500 event schedule, real time clock & 40,000 event audit trail			
DL4100IC/10B-S	Schlage IC Core	10B	Standard ANSI A115 Series prep	\$1,806.97
	<b>Users:</b> Holds up to 2000 codes, Master, Management, Supervisor & basic user. Multiple "one-time" user codes. 500 event schedule, real time clock & 40,000 event audit trail			
DL4100IC/10B-C	Corbin Russwin IC Core	10B	Standard ANSI A115 Series prep	\$1,806.97
	<b>Users:</b> Holds up to 2000 codes, Master, Management, Supervisor & basic user. Multiple "one-time" user codes. 500 event schedule, real time clock & 40,000 event audit trail			
DL4100IC/10B-Y	Yale IC Core	10B	Standard ANSI A115 Series prep	\$1,806.97
	<b>Users:</b> Holds up to 2000 codes, Master, Management, Supervisor & basic user. Multiple "one-time" user codes. 500 event schedule, real time clock & 40,000 event audit trail			
DL4100IC/10B-R	Sargent IC Core	10B	Standard ANSI A115 Series prep	\$1,806.97
	<b>Users:</b> Holds up to 2000 codes, Master, Management, Supervisor & basic user. Multiple "one-time" user codes. 500 event schedule, real time clock & 40,000 event audit trail			

## PDL3000 Series

High-security, standalone access control lock that combines PIN code entry and prox card access, Will read 26-37 bit HID card and keyfob formats.

- Door Thickness:** Fits 1 5/8" to 1 7/8"
- Backset:** 2 3/4" (2 3/8" also available)
- Strike:** 1 1/8" x 2 3/4" T strike & 1 1/4" x 4 7/8" ASA strike included
- Latchbolt:** UL Listed, fire rated 3 hours, 1/2" throw reversible
- Handing:** Non-handed
- Power:** 5 AA alkaline batteries (included)
- Keypad:** Weatherproof all metal, 12 button. All functions programmed through keypad. Proximity antenna housing molded of ultra high strength, impact resistant Lexan®
- Compliances:** BHMA Certified Grade 1 heavy duty cylindrical lockset. UL listed 10C Positive Pressure Specification. ADA compliant levers
- Cylinder:** 6 pin solid brass, SC1 keyway, furnished with all key override locks. Schlage, Corbin-Russwin CL, Sargent 480 series, ASSA 65-611 & Lori cylinders can also be used with HW620 tailpiece (supplied)
- Interchangeable Core Models:** Standard model accepts 6 & 7 pin cylinders from Best, Falcon, Arrow, KSP, Medeco Keymark & Kaba Peaks. IC core models prepped for 6 and 7 pin Yale, Medeco, Sargent, Corbin-Russwin & Schlage are also available



Part No.	Special Features	Finish	Prep	List Price
PDL3000/26D	Standard Key override	26D	Standard ANSI A115 Series prep	\$2,937.13
	<b>Users:</b> Holds up to 2000 codes, Master, Management, Supervisor & basic user. Multiple "one-time" user codes. 500 event schedule, real time clock & 40,000 event audit trail.			
PDL3000IC/10B-C	Corbin Russwin IC Core	10B	Standard ANSI A115 Series prep	\$3,097.11
	<b>Users:</b> Holds up to 2000 codes, Master, Management, Supervisor & basic user. Multiple "one-time" user codes. 500 event schedule, real time clock & 40,000 event audit trail.			
PDL3000IC/10B-M	Medeco IC Core	10B	Standard ANSI A115 Series prep	\$3,097.11
	<b>Users:</b> Holds up to 2000 codes, Master, Management, Supervisor & basic user. Multiple "one-time" user codes. 500 event schedule, real time clock & 40,000 event audit trail.			
PDL3000IC/10B-R	Sargent IC Core	10B	Standard ANSI A115 Series prep	\$3,097.11
	<b>Users:</b> Holds up to 2000 codes, Master, Management, Supervisor & basic user. Multiple "one-time" user codes. 500 event schedule, real time clock & 40,000 event audit trail.			
PDL3000IC/10B-S	Schlage IC Core	10B	Standard ANSI A115 Series prep	\$3,097.11
	<b>Users:</b> Holds up to 2000 codes, Master, Management, Supervisor & basic user. Multiple "one-time" user codes. 500 event schedule, real time clock & 40,000 event audit trail.			
PL3000/26D	Standard key override	26D	Standard ANSI A115 Series prep	\$2,937.12
	<b>Users:</b> Holds up to 2000 codes, Master, Management, Supervisor & basic user. Multiple "one-time" user codes. 500 event schedule, real time clock & 40,000 event audit trail.			
PDL3000IC/26D	IC Core	26D	Standard ANSI A115 Series prep	\$2,985.12
	<b>Users:</b> Holds up to 2000 codes, Master, Management, Supervisor & basic user. Multiple "one-time" user codes. 500 event schedule, real time clock & 40,000 event audit trail.			
PDL3000IC/26D-M	Medeco IC Core	26D	Standard ANSI A115 Series prep	\$3,009.12
	<b>Users:</b> Holds up to 2000 codes, Master, Management, Supervisor & basic user. Multiple "one-time" user codes. 500 event schedule, real time clock & 40,000 event audit trail.			
PDL3000IC/26D-R	Sargent IC Core	26D	Standard ANSI A115 Series prep	\$3,009.12
	<b>Users:</b> Holds up to 2000 codes, Master, Management, Supervisor & basic user. Multiple "one-time" user codes. 500 event schedule, real time clock & 40,000 event audit trail.			

### PDL 3000 Series (continue)



Part No.	Special Features	Finish	Prep	List Price
PDL3000IC/26D-S	Schlage IC Core <b>Users:</b> Holds up to 2000 codes, Master, Management, Supervisor & basic user. Multiple "one-time" user codes. 500 event schedule, real time clock & 40,000 event audit trail.	26D	Standard ANSI A115 Series prep	\$3,009.12
PDL3000IC/26D-Y	Yale IC Core <b>Users:</b> Holds up to 2000 codes, Master, Management, Supervisor & basic user. Multiple "one-time" user codes. 500 event schedule, real time clock & 40,000 event audit trail.	26D	Standard ANSI A115 Series prep	\$3,009.12
PDL3000IC726D-C	Corbin IC Core 7 pin <b>Users:</b> Holds up to 2000 codes, Master, Management, Supervisor & basic user. Multiple "one-time" user codes. 500 event schedule, real time clock & 40,000 event audit trail.	26D	Standard ANSI A115 Series prep	\$3,009.12
PDL3000IC726D-Y	Yale IC Core 7 pin <b>Users:</b> Holds up to 2000 codes, Master, Management, Supervisor & basic user. Multiple "one-time" user codes. 500 event schedule, real time clock & 40,000 event audit trail.	26D	Standard ANSI A115 Series prep	\$3,009.12

### PDL5300 Series

Double sided electronic battery operated digital proximity lock. Programmable keypad on both sides of the door. Only primary keypad has data transfer capability. Will read 26-37 bit HID card and keyfob formats. Key override is only operable on the primary side. The key on the secondary side is use only to remove the lever and access the batteries.

- Door Thickness:** Fits 1 5/8" to 1 7/8".
- Backset:** 2 3/4" (2 3/8" also available)
- Strike:** 1 1/8"x 2 3/4" T strike & 1 1/4" x 4 7/8" ASA strike included
- Latchbolt:** UL Listed, fire rated 3 hours, 1/2" throw reversible
- Handing:** Non-handed
- Power:** 5 AA alkaline batteries (included)
- Keypad:** Weatherproof all metal, 12 button. All functions programmed through keypad. Proximity antenna housing molded of ultra high strength, impact resistant Lexan®
- Compliances:** BHMA Certified Grade 1 heavy duty cylindrical lockset. UL listed 10C Positive Pressure Specification. ADA compliant levers
- Cylinder:** 6 pin solid brass, SC1 keyway, furnished with all key override locks. Schlage, Corbin-Russwin CL, Sargent 480 series, ASSA 65-611 & Lori cylinders can also be used with HW620 tailpiece (supplied)
- Interchangeable Core Models:** Standard model accepts 6 & 7 pin cylinders from Arrow Only



Part No.	Special Features	Finish	Prep	List Price
PDL5300/26D	Standard key override <b>Users:</b> Holds up to 2000 codes, Master, Management, Supervisor & basic user. Multiple "one-time" user codes. 500 event schedule, 40,000 event audit trail	26D	Standard ANSI A115 Series prep	\$3,564.24
PDL5300IC/26D	IC Core <b>Users:</b> Holds up to 2000 codes, Master, Management, Supervisor & basic user. Multiple "one-time" user codes. 500 event schedule, 40,000 event audit trail	26D	Standard ANSI A115 Series prep	\$3,591.43

## PDL4100 Series

Electronic battery operated digital proximity lock. Will read 26-37 HID card and keyfob formats. Privacy feature will lock out all basic users for a programmed amount of time. Residency feature-allows exiting without having to lock the door.

- Door Thickness:** Fits 1 5/8" to 1 7/8".
- Backset:** 2 3/4" (2 3/8" also available)
- Strike:** 1 1/8"x 2 3/4" T strike & 1 1/4" x 4 7/8" ASA strike included
- Latchbolt:** UL Listed, fire rated 3 hours, 1/2" throw reversible
- Handing:** Non-handed
- Power:** 5 AA alkaline batteries (included)
- Keypad:** Weatherproof all metal, 12 button. All functions programmed through keypad. Proximity antenna housing molded of ultra high strength, impact resistant Lexan®
- Door prep:** Standard ANSI A115 Series prep, modified by adding additional through-bolt holes
- Compliances:** BHMA certified Grade 1 heavy duty cylindrical lockset. UL listed to the 10C Positive Pressure Specification. ADA compliant levers
- Cylinder:** 6 pin solid brass, SC1 keyway, furnished with all key override locks. Schlage, Corbin-Russwin CL, Sargent 480 series, ASSA 65-611 & Lori cylinders can also be used with HW620 tailpiece (supplied)
- Interchangeable Core Models:** Standard model accepts 6 & 7 pin cylinders from Arrow, KSP, Medeco Keymark & Kaba Peaks. IC core models prepped for 6 pin and 7 pin Yale, Medeco, Sargent, Corbin-Russwin & Schlage are also available



Part No.	Special Features	Finish	Prep	List Price
PDL4100/10B	Standard Key override	10B	Standard ANSI A115 Series prep	\$2,524.39
	<b>Users:</b> Holds up to 2000 codes, Master, Management, Supervisor & basic user. Multiple "one-time" user codes. 500 event schedule, real time clock & 40,000 event audit trail			
PDL4100IC/10B	IC Core	10B	Standard ANSI A115 Series prep	\$2,560.86
	<b>Users:</b> Holds up to 2000 codes, Master, Management, Supervisor & basic user. Multiple "one-time" user codes. 500 event schedule, real time clock & 40,000 event audit trail			
PDL4100IC/10B-S	Schlage IC Core	10B	Standard ANSI A115 Series prep	\$2,583.65
	<b>Users:</b> Holds up to 2000 codes, Master, Management, Supervisor & basic user. Multiple "one-time" user codes. 500 event schedule, real time clock & 40,000 event audit trail			
PDL4100IC/10B-Y	Yale IC Core	10B	Standard ANSI A115 Series prep	\$2,583.65
	<b>Users:</b> Holds up to 2000 codes, Master, Management, Supervisor & basic user. Multiple "one-time" user codes. 500 event schedule, real time clock & 40,000 event audit trail			
PDL4100IC/10B-C	Corbin Russwin IC Core	10B	Standard ANSI A115 Series prep	\$2,583.65
	<b>Users:</b> Holds up to 2000 codes, Master, Management, Supervisor & basic user. Multiple "one-time" user codes. 500 event schedule, real time clock & 40,000 event audit trail			
PDL4100IC/10B-R	Sargent IC Core	10B	Standard ANSI A115 Series prep	\$2,583.65
	<b>Users:</b> Holds up to 2000 codes, Master, Management, Supervisor & basic user. Multiple "one-time" user codes. 500 event schedule, real time clock & 40,000 event audit trail			
PDL4100IC/10B-M	Medeco IC Core	10B	Standard ANSI A115 Series prep	\$2,583.65
	<b>Users:</b> Holds up to 2000 codes, Master, Management, Supervisor & basic user. Multiple "one-time" user codes. 500 event schedule, real time clock & 40,000 event audit trail			
PDL4100/26D	Standard key override	26D	Standard ANSI A115 Series prep	\$2,386.48
	<b>Users:</b> Holds up to 2000 codes, Master, Management, Supervisor & basic user. Multiple "one-time" user codes. 500 event schedule, real time clock & 40,000 event audit trail			
PDL4100IC/26D	IC Core	26D	Standard ANSI A115 Series prep	\$2,409.28
	<b>Users:</b> Holds up to 2000 codes, Master, Management, Supervisor & basic user. Multiple "one-time" user codes. 500 event schedule, real time clock & 40,000 event audit trail			

### PDL4100 Series (continue)

Part No.	Special Features	Finish	Prep	List Price
PDL4100IC/26D-S	Schlage IC Core	26D	Standard ANSI A115 Series prep	\$2,432.07
	<b>Users:</b> Holds up to 2000 codes, Master, Management, Supervisor & basic user. Multiple "one-time" user codes. 500 event schedule, real time clock & 40,000 event audit trail			
PDL4100IC/26D-Y	Yale IC Core	26D	Standard ANSI A115 Series prep	\$2,432.07
	<b>Users:</b> Holds up to 2000 codes, Master, Management, Supervisor & basic user. Multiple "one-time" user codes. 500 event schedule, real time clock & 40,000 event audit trail			
PDL4100IC/26D-C	Corbin Russwin IC Core	26D	Standard ANSI A115 Series prep	\$2,432.07
	<b>Users:</b> Holds up to 2000 codes, Master, Management, Supervisor & basic user. Multiple "one-time" user codes. 500 event schedule, real time clock & 40,000 event audit trail			
PDL4100IC/26D-R	Sargent IC Core	26D	Standard ANSI A115 Series prep	\$2,432.07
	<b>Users:</b> Holds up to 2000 codes, Master, Management, Supervisor & basic user. Multiple "one-time" user codes. 500 event schedule, real time clock & 40,000 event audit trail			
PDL4100IC/26D-M	Medeco IC Core	26D	Standard ANSI A115 Series prep	\$2,432.07
	<b>Users:</b> Holds up to 2000 codes, Master, Management, Supervisor & basic user. Multiple "one-time" user codes. 500 event schedule, real time clock & 40,000 event audit trail			



## DL3500 Series

DL3500 is a Grade 1 mortise lock in Alarm Lock's Trilogy® T3 family, offering PIN-based access, audit trail logging, and time-based scheduling, all in a standalone, non-networked format with classroom or deadbolt option.

- Door Thickness:** Fits 1 3/8" to 1 7/8" (4.46cm). Backset:
- Strike:** 1 1/4" x 4 7/8" strike included
- Handing:** Specify RH or LH when ordering, lock is reversible in the field
- Power:** 5 AA alkaline batteries (included)
- Keypad:** All metal, 12 button. All functions programmed through keypad.
- Compliances:** Steelcase lock body meets BHMA specifications for Grade 1 locks. UL listed to the 10C Positive Pressure Specification. ADA compliant levers
- Functions:** Classroom function feature stainless steel latchbolt with 3/4" (1.91cm) projection and deadlocking latch Deadbolt function feature stainless steel deadbolt with 1" (2.55cm) projection, latchbolt with 3/4" (1.91cm) projection and deadlocking latch Deadbolt may be projected from key cylinder from outside door or turn-piece from inside door.
- Cylinder:** 1 3/8" (3.5cm) mortise cylinder supplied. Will Accept 1 3/8" to 1 1/2" (3.5 - 3.82cm) mortise Cylinder.
- Cams:** Classroom function supplied with straight Cam and deadbolt function supplied with cloverleaf Cam. Cams for other manufacturer's cylinders are available See "Mortise Lock accessories" for part numbers & Manufacturers.



Part No.	Special Features	Finish	Prep	List Price
DL3500CRL/10B	Straight lever classroom function Left Hand	10B	Standard ANSI A115 Mortise prep	\$2,544.88
	<b>Users:</b> Holds - up to 300 codes, Master, Management, Supervisor & basic - user. 500 event schedule, real time clock & 40,000 event audit trail			
DL3500CRL/26D	Straight lever classroom function Right Hand	26D	Standard ANSI A115 Mortise prep	\$2,425.21
	<b>Users:</b> Holds - up to 300 codes, Master, Management, Supervisor & basic - user. 500 event schedule, real time clock & 40,000 event audit trail			
DL3500CRR/26D	Straight lever classroom function Right Hand	26D	Standard ANSI A115 Mortise prep	\$2,425.21
	<b>Users:</b> Holds - up to 300 codes, Master, Management, Supervisor & basic - user. 500 event schedule, real time clock & 40,000 event audit trail			
DL3500DBL/26D	Straight lever deadbolt function Left Hand	26D	Standard ANSI A115 Mortise prep	\$2,425.21
	<b>Users:</b> Holds - up to 300 codes, Master, Management, Supervisor & basic - user. 500 event schedule, real time clock & 40,000 event audit trail			
DL3500DBR/26D	Straight lever deadbolt function Right Hand	26D	Standard ANSI A115 Mortise prep	\$2,425.21
	<b>Users:</b> Holds - up to 300 codes, Master, Management, Supervisor & basic - user. 500 event schedule, real time clock & 40,000 event audit trail			

## DL4500 Series

Electronic battery operated digital proximity lock, Privacy feature will lock out all basic users for programmed amount of time. Residency feature—allows exiting without having to lock the door.

- Door Thickness:** Fits 1 3/8" to 1 7/8" (4.46cm). Backset:
- Strike:** 1 1/4" x 4 7/8" strike included
- Handing:** Specify RH or LH when ordering, lock is reversible in the field
- Power:** 5 AA alkaline batteries (included)
- Keypad:** All metal, 12 button. All functions programmed through keypad.
- Compliances:** Steelcase lockbody meets BHMA specifications for Grade 1 locks. UL listed to the 10C Positive Pressure Specification. ADA compliant levers
- Functions:** Deadbolt function feature stainless steel deadbolt with 1" (2.55cm) projection, latchbolt with 3/4" (1.91cm) projection and deadlocking latch Deadbolt may be projected from key cylinder from outside door or turn-piece from inside door.
- Cylinder:** 1 3/8" (3.5cm) mortise cylinder supplied. Will Accept 1 3/8" to 1 1/2" (3.5 – 3.82cm) mortise Cylinder. Deadbolt function supplied with cloverleaf Cam
- Cams:** Supplied with cloverleaf cam. Cams for other manufacturer's cylinders are available See "Mortise Lock accessories" for part numbers & Manufacturers



Part No.	Special Features	Finish	Prep	List Price
DL4500DBL/26D	Straight lever deadbolt function Left hand	26D	Standard ANSI A115 Mortise prep	\$1,826.92
	<b>Users:</b> Holds up to 2000 codes, Master, Management, Supervisor & basic user. 500 event schedule, real time clock & 40,000 event audit trail.			
DL4500DBR/26D	Straight lever deadbolt function Right hand	26D	Standard ANSI A115 Mortise prep	\$1,826.92
	<b>Users:</b> Holds up to 2000 codes, Master, Management, Supervisor & basic user. 500 event schedule, real time clock & 40,000 event audit trail.			

## PDL3500/PL3500 Series

Heavy-Duty Proximity Mortise Lock offers secure access using a proximity card and PIN code, eliminating the need for traditional keys. HID II 26-37 bit card format.

- Door Thickness:** Fits 1 3/8" to 1 7/8" (4.46cm). Backset:
- Strike:** 1 1/4" x 4 7/8" strike included
- Handing:** Specify RH or LH when ordering, lock is reversible in the field
- Power:** 5 AA alkaline batteries (included)
- Keypad:** Weatherproof all metal, 12 button. All functions programmed through keypad. Proximity antenna housing molded of ultra high strength, impact resistant Lexan®
- Compliances:** Steelcase lockbody meets BHMA specifications for Grade 1 locks. UL listed to the 10C Positive Pressure Specification. FCC Certified. ADA compliant levers
- Functions:** Classroom function feature stainless steel latchbolt with 3/4" (1.91cm) projection & deadlocking latch Deadbolt function feature stainless steel deadbolt with 1" (2.55cm) projection, latchbolt with 3/4" (1.91cm) projection and deadlocking latch Deadbolt may be projected from key cylinder from outside door or turn-piece from inside door
- Cylinder:** 1 3/8" (3.5cm) mortise cylinder supplied. Will Accept 1 1/4" to 1 1/2" (3.5 - 3.82cm) mortise Cylinder. Classroom function supplied with straight Cam and deadbolt function supplied with cloverleaf Cam
- Cams:** Classroom function supplied with straight cam. Deadbolt function supplied with cloverleaf cam. Cams for other manufacturer's cylinders are available See "Mortise Lock accessories" for part numbers & Manufacturers



Part No.	Special Features	Finish	Prep	List Price
PDL3500CRL/26D	Straight lever classroom function Left hand	26D	Standard ANSI A115 Mortise prep	\$3,103.51
	<b>Users:</b> Holds up to 2000 - user codes, Master, Management, Supervisor & basic user. 500 scheduled events, real time clock & 40,000 event audit trail.			
PDL3500CRR/26D	Straight lever classroom function Right hand	26D	Standard ANSI A115 Mortise prep	\$3,103.51
	<b>Users:</b> Holds up to 2000 - user codes, Master, Management, Supervisor & basic user. 500 scheduled events, real time clock & 40,000 event audit trail.			
PDL3500DBL/26D	Straight lever deadbolt function Left hand	26D	Standard ANSI A115 Mortise prep	\$3,103.51
	<b>Users:</b> Holds up to 2000 - user codes, Master, Management, Supervisor & basic user. 500 scheduled events, real time clock & 40,000 event audit trail.			
PDL3500DBR/26D	Straight lever deadbolt function Right hand	26D	Standard ANSI A115 Mortise prep	\$3,103.51
	<b>Users:</b> Holds up to 2000 - user codes, Master, Management, Supervisor & basic user. 500 scheduled events, real time clock & 40,000 event audit trail.			
PL3500CRL/26D	Prox Only, Straight lever classroom function Left hand	26D	Standard ANSI A115 Mortise prep	\$3,103.51
	<b>Users:</b> Holds up to 2000 - user codes, Master, Management, Supervisor & basic user. 500 scheduled events, real time clock & 40,000 event audit trail.			
PL3500CRR/26D	Prox Only, Straight lever classroom function Right hand	26D	Standard ANSI A115 Mortise prep	\$3,103.51
	<b>Users:</b> Holds up to 2000 - user codes, Master, Management, Supervisor & basic user. 500 scheduled events, real time clock & 40,000 event audit trail.			
PL3500DBL/26D	Prox Only, Straight lever deadbolt function Left hand	26D	Standard ANSI A115 Mortise prep	\$3,103.52
	<b>Users:</b> Holds up to 2000 - user codes, Master, Management, Supervisor & basic user. 500 scheduled events, real time clock & 40,000 event audit trail.			
PL3500DBR/26D	Prox Only, Straight lever deadbolt function Right hand	26D	Standard ANSI A115 Mortise prep	\$3,103.51
	<b>Users:</b> Holds up to 2000 - user codes, Master, Management, Supervisor & basic user. 500 scheduled events, real time clock & 40,000 event audit trail.			

## PDL4500 Series

Electronic battery operated digital proximity lock. Will read 26-37 bit HID card and keyfob formats. Privacy feature will lock out all users for a programmed amount of time. Residency feature-allows exiting without having to lock the door.

- Door Thickness:** Fits 1 3/8" to 1 7/8" (4.46cm). Backset:
- Strike:** 1 1/4" x 4 7/8" strike included
- Handing:** Specify RH or LH when ordering, lock is reversible in the field
- Power:** 5 AA alkaline batteries (included)
- Keypad:** Weatherproof all metal, 12 button. All functions programmed through keypad. Proximity antenna housing molded of ultra high strength, impact resistant Lexan®
- Compliances:** Steelcase lockbody meets BHMA specifications for Grade 1 locks. UL listed to the 10C Positive Pressure Specification. ADA compliant levers
- Functions:** Deadbolt function feature stainless steel deadbolt with 1" (2.55cm) projection, latchbolt with 3/4" (1.91cm) projection and deadlocking latch Deadbolt may be projected from key cylinder from outside door or turn-piece from inside door
- Cylinder:** 1 3/8" (3.5cm) mortise cylinder supplied. Will accept 1 3/8" to 1 1/2" (3.5 - 3.8cm) mortise cylinder. Deadbolt function supplied with cloverleaf cam
- Cams:** Supplied with cloverleaf cam. Cams for other manufacturer's cylinders are available See "Mortise Lock accessories" for part numbers & Manufacturers



Part No.	Special Features	Finish	Prep	List Price
PDL4500DBL/26D	Straight lever deadbolt function Left hand	26D	Standard ANSI A115 Mortise prep	\$2,661.98
	<b>Users:</b> Holds up to 2000 codes, Master, Management, Supervisor & basic user. 500 event schedule, real time clock & 40,000 event audit trail			
PDL4500DBR/26D	Straight lever deadbolt function Right hand	26D	Standard ANSI A115 Mortise prep	\$2,661.98
	<b>Users:</b> Holds up to 2000 codes, Master, Management, Supervisor & basic user. 500 event schedule, real time clock & 40,000 event audit trail			

## DL1200 Series

Keypad Only Aluminum door retrofit outside trim, Works with Adams Rite® 4500, 4700 & 4900 series deadlatch. 4070, MS18505 & MS19505 series deadbolts.

- Door thickness:** 1 3/4" only
- Backset:** 31/32", 1 1/8", & 1 1/2"
- Handing:** Non-handed
- Power:** Uses 2 DL123A lithium batteries
- Keypad:** All metal, vandal resistant 12 button keypad supports 3-5 digit PIN codes
- Cylinder:** Supplied with 6 pin mortise standard mortise cylinder SC1 Keypad. Use 1 3/8" or 1 1/2" cylinders
- Cams:** Cam supplied works with generic Alarm Lock cylinder. Other Standard cams available for Best, Corbin-Russwin, Medeco, Schlage & Yale are also available

Part No.	Special Features	Finish	List Price
DL1200/10B1	Lever set works with Adams Rite® 4500, 4700, & 4900 series deadlatch	10B	\$1,166.88
	<b>Users:</b> 100 user codes, master, - Manager, basic user and 3 "one-time" user codes		
DL1200/26D1	Lever set works with Adams Rite® 4500, 4700, & 4900 series deadlatch	26D	\$1,166.88
	<b>Users:</b> 100 user codes, master, - Manager, basic user and 3 "one-time" user codes		
DL1225/10B2	Thumb turn works with Adams Rite® 4070, MS18505, MS1950 series deadbolt	10B	\$1,166.88
	<b>Users:</b> 100 user codes, master, - Manager, basic user and 3 "one-time" user codes		
DL1225/26D2	Thumb turn works with Adams Rite® 4070, MS18505, MS1950 series deadbolt	26D	\$1,166.88
	<b>Users:</b> 100 user codes, master, - Manager, basic user and 3 "one-time" user codes		
DL1250/10B2	Knob works with Adams Rite® 4070, MS18505, MS1950 series deadbolt	10B	\$1,166.88
	<b>Users:</b> 100 user codes, master, - Manager, basic user and 3 "one-time" user codes		
DL1250/26D2	Knob works with Adams Rite® 4070, MS18505, MS1950 series deadbolt	26D	\$1,166.88
	<b>Users:</b> 100 user codes, master, - Manager, basic user and 3 "one-time" user codes		



## DL1300 Series

Keypad Only Aluminum door retrofit outside trim, Works with Adams Rite® 1850, 1950, 4710, 4070, 4730, 4900 series spring latch and MS18505 & MS19505 series deadbolts.

- Door thickness:** 1 3/4" only
- Backset:** 31/32", 1 1/8", & 1 1/2"
- Latch:** Sorks with Adams Rite® 1850, 1950, 4710, 4070, 4730, 4900 Series spring latch and MS1850S & MS1950S series deadbolts
- Handing:** Son-handed
- Power:** Uses 2 DL123A lithium batteries
- Keypad:** All metal, vandal resistant 12 button keypad supports 3-5 digit PIN codes
- Cylinder:** Supplied with 6 pin mortise standard mortise cylinder SC1 Keyway. Use 1 3/8" or 1 1/2" cylinders for Corbin-Russwin, Marks, Arrow, Sargent & Schlage. IC type cams for Best, Corbin-Russwin, Medeco, Schlage & Yale are also available
- Cams:** Cam supplied works with generic Alarm Lock cylinder. Other Standard cams available for Corbin-Russwin, Marks, Arrow, Sargent & Schlage. IC type cams for Best, Corbin-Russwin, Medeco, Schlage & Yale are also available



Part No.	Special Features	Finish	List Price
DL1300/10B1	Lever set works with Adams Rite® 4500, 4700, & 4900 series deadlatch	10B	\$1,348.59
	<b>Users:</b> 2,000 user codes, master, Manager, basic user and multiple "one-time" user codes. 500 event schedule, real time clock & 40,000 event audit trail.		
DL1300/26D1	Lever set works with Adams Rite® 4500, 4700, & 4900 series deadlatch	26D	\$1,348.59
	<b>Users:</b> 2,000 user codes, master, Manager, basic user and multiple "one-time" user codes. 500 event schedule, real time clock & 40,000 event audit trail.		
DL1325/26D2	Thumb turn works with Adams Rite® 4070, MS18505, MS1950 series deadbolt	26D	\$1,348.59
	<b>Users:</b> 2,000 user codes, master, Manager, basic user and multiple "one-time" user codes. 500 event schedule, real time clock & 40,000 event audit trail.		
DL1325/10B2	Thumb turn works with Adams Rite® 4070, MS18505, MS1950 series deadbolt	10B	\$1,348.59
	<b>Users:</b> 2,000 user codes, master, Manager, basic user and multiple "one-time" user codes. 500 event schedule, real time clock & 40,000 event audit trail.		
DL1350/26D2	Knob works with Adams Rite® 4070, MS18505, MS1950 series deadbolt	26D	\$1,348.59
	<b>Users:</b> 2,000 user codes, master, Manager, basic user and multiple "one-time" user codes. 500 event schedule, real time clock & 40,000 event audit trail.		
DL1350/10B2	Knob works with Adams Rite® 4070, MS18505, MS1950 series deadbolt	10B	\$1,348.59
	<b>Users:</b> 2,000 user codes, master, Manager, basic user and multiple "one-time" user codes. 500 event schedule, real time clock & 40,000 event audit trail.		

## PDL1300 Series

Aluminum door retrofit outside trim w/ Prox capabilities, Works with Adams Rite® 1850, 1950, 4710, 4070, 4730, 4900 series spring latch and MS1850S & MS1950S series deadbolts. HID II 26-37 bit cards.

- Door thickness:** 1 ¾" only
- Backset:** 31/32", 1 1/8", & 1 ½"
- Latch:** Sorks with Adams Rite® 1850, 1950, 4710, 4070, 4730, 4900 Series spring latch and MS1850S & MS1950S series deadbolts
- Handing:** Son-handed
- Power:** Uses 2 DL123A lithium batteries
- Keypad:** All metal, vandal resistant 12 button keypad supports 3-5 digit PIN codes and HID proximity cards & fobs. Proximity antenna housing molded of ultra high strength, impact resistant Lexan®
- Cylinder:** Supplied with 6 pin mortise standard mortise cylinder SC1 Keyway. Use 1 3/8" or 1 ½" cylinders
- Cams:** Cam supplied works with generic Alarm Lock cylinder. Other Standard cams available for Corbin-Russwin, Marks, Arrow, Sargent & Schlage. IC type cams for Best, Corbin-Russwin, Medeco, Schlage & Yale are also available



Part No.	Special Features	Finish	List Price
PDL1300/10B1	Lever set works with Adams Rite® 4500, 4700, & 4900 series deadlatch	10B	\$1,954.90
	<b>Users:</b> 2,000 user codes, master, Manager, basic user and multiple "one-time" user codes. 500 event schedule, real time clock & 40,000 event audit trail.		
PDL1300/26D1	Lever set works with Adams Rite® 4500, 4700, & 4900 series deadlatch	26D	\$1,954.90
	<b>Users:</b> 2,000 user codes, master, Manager, basic user and multiple "one-time" user codes. 500 event schedule, real time clock & 40,000 event audit trail.		
PDL1325/10B2	Thumb turn works with Adams Rite® 4070, MS1850S, MS1950 series deadbolt	10B	\$1,954.90
	<b>Users:</b> 2,000 user codes, master, Manager, basic user and multiple "one-time" user codes. 500 event schedule, real time clock & 40,000 event audit trail.		
PDL1325/26D2	Digital w/ Prox, Thumb turn works with Adams Rite® 4070, MS1850S, MS1950 series deadbolt	26D	\$1,954.90
	<b>Users:</b> 2,000 user codes, master, Manager, basic user and multiple "one-time" user codes. 500 event schedule, real time clock & 40,000 event audit trail.		
PDL1350/10B2	Knob works with Adams Rite® 4070, MS1850S, MS1950 series deadbolt	10B	\$1,954.90
	<b>Users:</b> 2,000 user codes, master, Manager, basic user and multiple "one-time" user codes. 500 event schedule, real time clock & 40,000 event audit trail.		
PDL1350/26D2	Knob works with Adams Rite® 4070, MS1850S, MS1950 series deadbolt	26D	\$1,954.90
	<b>Users:</b> 2,000 user codes, master, Manager, basic user and multiple "one-time" user codes. 500 event schedule, real time clock & 40,000 event audit trail.		

## DL1200ET, DL1300ET & PDL1300ET Series

Aluminum door retrofit outside trim. Works with Arrow, DCI, Von Duprin, Corbin, Dor-o-matic, Dorma & Jackson. PDL1300ET also has proximity capabilities.

- Door thickness:** 1 3/4" only  
**Handing:** Non-handed  
**Power:** Uses 2 DL123A lithium batteries  
**Keypad:** All metal, vandal resistant 12 button keypad supports 3-5 digit PIN codes  
**Cylinder:** Supplied with 6 pin mortise standard mortise cylinder SC1 Keyway. Use 1 3/8" or 1 1/2" cylinders  
**Cams:** Cam supplied works with generic Alarm Lock cylinder. Other Standard cams available for Corbin-Russwin, Marks, Arrow, Sargent & Schlage. IC type cams for Best, Corbin-Russwin, Medeco, Schlage & Yale are also available.

**Must order separate tailpiece for specific ET being installed**

**Note:** ET Trim works w/V33 LH (RHR) only

**ALL NARROW STILE/EXIT LOCKS ARE WEATHER RESISTANT**



Part No.	Special Features	Finish	List Price
DL1200ET/26D	Keypad Only, Straight Lever Lock Arrow S1200/S1250, DCI 1200/1300, Von Duprin 22, Corbin ED8200 & Von Duprin 33 panic LH (RHR) devices only <b>Users:</b> 100 user codes, master, Manager, basic user and 3 "one-time" user codes.	26D	\$1,166.88
DL1200ET/10B	Keypad Only, Straight Lever for Arrow S1200/S1250, DCI 1200/1300, Von Duprin 22, Corbin ED8200 & Von Duprin 33 panic LH (RHR) devices only <b>Users:</b> 100 user codes, master, Manager, basic user and 3 "one-time" user codes.	10B	\$1,166.88
DL1225ET/26D	Keypad Only, Turnpiece for Dor-o-Matic 2090, Jackson 1095 & Dorma 5300 panic devices <b>Users:</b> 100 user codes, master, Manager, basic user and 3 "one-time" user codes.	26D	\$1,166.88
DL1225ET/10B	Keypad Only, Turnpiece for Dor-o-Matic 2090, Jackson 1095 & Dorma 5300 panic devices <b>Users:</b> 100 user codes, master, Manager, basic user and 3 "one-time" user codes.	10B	\$1,166.88
DL1250ET/26D	Keypad Only, Knob for Dor-o-Matic 2090, Jackson 1095 & Dorma 5300 panic devices <b>Users:</b> 100 user codes, master, Manager, basic user and 3 "one-time" user codes.	26D	\$1,166.88
DL1250ET/10B	Keypad Only, Knob for Dor-o-Matic 2090, Jackson 1095 & Dorma 5300 panic devices <b>Users:</b> 100 user codes, master, Manager, basic user and 3 "one-time" user codes.	10B	\$1,166.88
TP-1691	ARROW, DCI, VON DUPRIN TAILPC		\$94.32
TP-1692	DOR-O-MATIC 2090		\$94.32
TP-1693	CORBIN ED8200 TAILPIECE		\$94.32
TP-1694	VON DUPRIN 33 TAILPIECE		\$94.32
TP-1698	JACKSON 1095		\$94.32

## DL1200ET, DL1300ET & PDL1300ET Series (continue)

Part No.	Special Features	Finish	List Price
DL1300ET/26D	Keypad Only, Straight Lever for Arrow S1200/S1250, DCI 1200/1300, Von Duprin 22, Corbin ED8200 & Von Duprin 33 LH (RHR) devices only	26D	\$1,348.59
	<b>Users:</b> 2,000 user codes, multiple "one-time" user codes. 500 event schedule, real time clock & 40,000 event audit trail.		
PDL1300ET/26D	Digital w/ Prox, Straight lever for Arrow S1200/S1250, DCI 1200/1300, Von Duprin 22, Corbin ED8200 & Von Duprin 33 LH (RHR) devices only	26D	\$1,954.90
	<b>Users:</b> 2,000 user codes, multiple "one-time" user codes. 500 event schedule, real time clock & 40,000 event audit trail.		
PDL1325ET/26D	Digital w/ Prox, Turnpiece for Dor-o-Matic 2090, Jackson 1095 & Dorma 5300 panic devices	26D	\$1,954.90
	<b>Users:</b> 2,000 user codes, multiple "one-time" user codes. 500 event schedule, real time clock & 40,000 event audit trail.		
PDL1325ET/10B	Digital w/ Prox, Turnpiece for Dor-o-Matic 2090, Jackson 1095 & Dorma 5300 panic devices	10B	\$1,954.90
	<b>Users:</b> 2,000 user codes, multiple "one-time" user codes. 500 event schedule, real time clock & 40,000 event audit trail.		
PDL1350ET/26D	Digital w/ Prox, Knob for Dor-o-Matic 2090, Jackson 1095 & Dorma 5300 panic devices	26D	\$1,954.90
	<b>Users:</b> 2,000 user codes, multiple "one-time" user codes. 500 event schedule, real time clock & 40,000 event audit trail.		
PDL1350ET/10B	Digital w/ Prox, Knob for Dor-o-Matic 2090, Jackson 1095 & Dorma 5300 panic devices	10B	\$1,954.90
	<b>Users:</b> 2,000 user codes, multiple "one-time" user codes. 500 event schedule, real time clock & 40,000 event audit trail.		



## TRILOGY EXIT TRIM PRODUCTS

Battery operated Trilogy outside trim works with Marks M9900, Von Duprin 99, Corbin ED5000, Yale 7100, Dorma 9300, Arrow 3800, Sargent 8800, Precision 1100, 2100 & Cal Royal 9800, series panic devices. Available in DL series (keypad) or PDL (prox/keypad) formats.

- Cylinder:** Uses standard rim cylinder to operate key override function.  
Will accept 6 or 7 pin interchangeable core cylinders – see below.
- Handing:** Non-handed
- Power:** 5 AA alkaline batteries (included) mounted on inside of door.
- Keypad:** Weather-resistant all metal, 12 button. All functions Programmable through the keypad.  
PDL version proximity antenna housing molded of ultra high strength, impact resistant Lexan®.
- Note:** All units are shipped with "1" option. For thicker door preps, you must order extended spindle and screw kit separately. Also, a generic rim cylinder & adapter kit are included in all locks.



Part No.	Special Features	Finish	Prep	List Price
ETDL27S1G26DM99	Keypad Only, T2 Series, Straight handle <b>Users:</b> 100 user codes, - 1 Master, 10 Manager	26D	Compatible w/ Marks M9900	\$1,521.96
ETDL27S1G26DV99	Keypad Only, T2 Series, Straight handle <b>Users:</b> 100 user codes, - 1 Master, 10 Manager	26D	Compatible w/ VonDuprin 99	\$1,521.96
ETDL27S1G26DY71	Keypad Only, T2 Series, Straight handle <b>Users:</b> 100 user codes, - 1 Master, 10 Manager	26D	Compatible w/ Yale 7100	\$1,521.96
ETDL27S1G26DNS8	Keypad Only, T2 Series, Straight handle <b>Users:</b> 100 user codes, - 1 Master, 10 Manager	26D	Compatible w/ New Sargent 8800	\$1,521.96
ETDL27R1G26DV99	Keypad Only, T2 Series, Straight handle <b>Users:</b> 100 user codes, - 1 Master, 10 Manager	26D	Compatible w/ VonDuprin 99	\$1,563.47
ETDLS1G/10BCR8	Keypad Only, Straight handle <b>Users:</b> 100 user codes, - 1 Master, 10 Manager	10B	Compatible w/ Cal Royal 9800	\$2,220.44
ETDLS1G/10BC50	Keypad Only, Straight handle <b>Users:</b> 100 user codes, - 1 Master, 10 Manager	10B	Compatible w/ Corbin ED5000	\$2,220.44
ETDLS1G/10BD93	Keypad Only, Straight handle <b>Users:</b> 100 user codes, - 1 Master, 10 Manager	10B	Compatible w/ Dorma 9300	\$2,220.44
ETDLS1G/10BM99	Keypad Only, Straight handle <b>Users:</b> 100 user codes, - 1 Master, 10 Manager	10B	Compatible w/ Marks M9900	\$2,220.44
ETDLS1G/10BNS8	Keypad Only, Straight handle <b>Users:</b> 100 user codes, - 1 Master, 10 Manager	10B	Compatible w/ Sargent 8800	\$2,220.44
ETDLS1G/10BP11	Keypad Only, Straight handle <b>Users:</b> 100 user codes, - 1 Master, 10 Manager	10B	Compatible w/ Precision 1100	\$2,220.44
ETDLS1G/10BS88	Keypad Only, Straight handle <b>Users:</b> 100 user codes, - 1 Master, 10 Manager	10B	Compatible w/ Sargent 8800	\$2,220.44
ETDLS1G/10BY71	Keypad Only, Straight handle <b>Users:</b> 100 user codes, - 1 Master, 10 Manager	10B	Compatible w/ Yale 7100	\$2,220.44
ETDLS1G/10BV99	Keypad Only, Straight handle <b>Users:</b> 100 user codes, - 1 Master, 10 Manager	10B	Compatible w/ VonDuprin 99	\$2,220.44

## TRILOGY EXIT TRIM PRODUCTS (continue)



Part No.	Special Features	Finish	Prep	List Price
ETDLS1G/26DM99	Keypad Only, Straight handle <b>Users:</b> 100 user codes, - 1 Master, 10 Manager	26D	Compatible w/ Marks M9900	\$2,111.67
ETDLS1G/26DM99K	Keypad Only, Straight handle, M99 Kit <b>Users:</b> 100 user codes, - 1 Master, 10 Manager	26D	Compatible w/ Marks M9900	\$2,765.95
ETDLS1G/26DCR8	Keypad Only, Straight handle <b>Users:</b> 100 user codes, - 1 Master, 10 Manager	26D	Compatible w/ Cal Royal 9800	\$2,111.67
ETDLS1G/26DC50	Keypad Only, Straight handle <b>Users:</b> 100 user codes, - 1 Master, 10 Manager	26D	Compatible w/ Corbin ED5000	\$2,111.67
ETDLS1G/26DD93	Keypad Only, Straight handle <b>Users:</b> 100 user codes, - 1 Master, 10 Manager	26D	Compatible w/ Dorma 9300	\$2,111.67
ETDLS1G/26DNS8	Keypad Only, Straight handle <b>Users:</b> 100 user codes, - 1 Master, 10 Manager	26D	Compatible w/ New Sargent 8800	\$2,111.67
ETDLS1G/26DP11	Keypad Only, Straight handle <b>Users:</b> 100 user codes, - 1 Master, 10 Manager	26D	Compatible w/ Precision 1100	\$2,111.67
ETDLS1G/26DS88	Keypad Only, Straight handle <b>Users:</b> 100 user codes, - 1 Master, 10 Manager	26D	Compatible w/ Sargent 8800	\$2,111.67
ETDLS1G/26DV99	Keypad Only, Straight handle <b>Users:</b> 100 user codes, - 1 Master, 10 Manager	26D	Compatible w/ VonDuprin 99	\$2,111.67
ETDLS1G/26DY71	Keypad Only, Straight handle <b>Users:</b> 100 user codes, - 1 Master, 10 Manager	26D	Compatible w/ Yale 7100	\$2,111.67
ETPDLS1G/10BCR8	Digital w/ prox, Straight Handle <b>Users:</b> Features include 2,000 user codes, 500 scheduled events & 40,000 event audit trail.	10B	Compatible w/ Cal Royal 9800	\$2,866.74
ETPDLS1G/10BC50	Digital w/ prox, Straight Handle <b>Users:</b> Features include 2,000 user codes, 500 scheduled events & 40,000 event audit trail.	10B	Compatible w/ Corbin ED5000	\$2,866.74
ETPDLS1G/10BD93	Digital w/ prox, Straight Handle <b>Users:</b> Features include 2,000 user codes, 500 scheduled events & 40,000 event audit trail.	10B	Compatible w/ Dorma 9300	\$2,866.74
ETPDLS1G/10BM99	Digital w/ prox, Straight Handle <b>Users:</b> Features include 2,000 user codes, 500 scheduled events & 40,000 event audit trail.	10B	Compatible w/ Marks M9900	\$2,866.74
ETPDLS1G/10BNS8	Digital w/ prox, Straight Handle <b>Users:</b> Features include 2,000 user codes, 500 scheduled events & 40,000 event audit trail.	10B	Compatible w/ New Sargent 8800	\$2,866.74
ETPDLS1G/10BP11	Digital w/ prox, Straight Handle <b>Users:</b> Features include 2,000 user codes, 500 scheduled events & 40,000 event audit trail.	10B	Compatible w/ Precision 1100	\$2,866.74
ETPDLS1G/10BS88	Digital w/ prox, Straight Handle <b>Users:</b> Features include 2,000 user codes, 500 scheduled events & 40,000 event audit trail.	10B	Compatible w/ Sargent 8800	\$2,866.74
ETPDLS1G/10BV99	Digital w/ prox, Straight Handle <b>Users:</b> Features include 2,000 user codes, 500 scheduled events & 40,000 event audit trail.	10B	Compatible w/ Yale 7100	\$2,866.74
ETPDLS1G/10BY71	Digital w/ prox, Straight Handle <b>Users:</b> Features include 2,000 user codes, 500 scheduled events & 40,000 event audit trail.	10B	Compatible w/ Yale 7100	\$2,866.74

## TRILOGY EXIT TRIM PRODUCTS (continue)



Part No.	Special Features	Finish	Prep	List Price
ETPDLS1G/26DCR8	Digital w/ prox, Straight Handle <b>Users:</b> Features include 2,000 user codes, 500 scheduled events & 40,000 event audit trail.	26D	Compatible w/ Cal Royal 9800	\$2,866.74
ETPDLS1G/26DC50	Digital w/ prox, Straight Handle <b>Users:</b> Features include 2,000 user codes, 500 scheduled events & 40,000 event audit trail.	26D	Compatible w/ Corbin ED5000	\$2,754.75
ETPDLS1G/26DD93	Digital w/ prox, Straight Handle <b>Users:</b> Features include 2,000 user codes, 500 scheduled events & 40,000 event audit trail.	26D	Compatible w/ Dorma 9300	\$2,754.75
ETPDLS1G/26DM99	Digital w/ prox, Straight Handle <b>Users:</b> Features include 2,000 user codes, 500 scheduled events & 40,000 event audit trail.	26D	Compatible w/ Marks M9900	\$2,754.75
ETPDLS1G/26DNS8	Digital w/ prox, Straight Handle <b>Users:</b> Features include 2,000 user codes, 500 scheduled events & 40,000 event audit trail.	26D	Compatible w/ New Sargent 8800	\$2,754.75
ETPDLS1G/26DP11	Digital w/ prox, Straight Handle <b>Users:</b> Features include 2,000 user codes, 500 scheduled events & 40,000 event audit trail.	26D	Compatible w/ Precision 1100	\$2,754.75
ETPDLS1G/26DS88	Digital w/ prox, Straight Handle <b>Users:</b> Features include 2,000 user codes, 500 scheduled events & 40,000 event audit trail.	26D	Compatible w/ Sargent 8800	\$2,754.75
ETPDLS1G/26DV99	Digital w/ prox, Straight Handle <b>Users:</b> Features include 2,000 user codes, 500 scheduled events & 40,000 event audit trail.	26D	Compatible w/ VonDuprin 99	\$2,754.75
ETPDLS1G/26DY71	Digital w/ prox, Straight Handle <b>Users:</b> Features include 2,000 user codes, 500 scheduled events & 40,000 event audit trail.	26D	Compatible w/ Yale 7100	\$2,754.75
ETPDLS1G26DM99K	Digital w/ prox, Straight Handle, M99 Kit <b>Users:</b> Features include 2,000 user codes, 500 scheduled events & 40,000 event audit trail.	26D	Compatible w/ Marks M9900	\$3,388.27
ETPLS1G/10BS88	Prox Only, Straight Handle <b>Users:</b> Features include 2,000 user codes, 500 scheduled events & 40,000 event audit trail.	10B	Compatible w/ Sargent 8800	\$2,866.74
ETPLS1G/10BV99	Prox Only, Straight Handle <b>Users:</b> Features include 2,000 user codes, 500 scheduled events & 40,000 event audit trail.	26D	Compatible w/ VonDuprin 99	\$2,866.74
ETPLS1G/26DCR8	Prox Only, Straight Handle <b>Users:</b> Features include 2,000 user codes, 500 scheduled events & 40,000 event audit trail.	26D	Compatible w/ Cal Royal 9800	\$2,754.75
ETPLS1G/26DC50	Prox Only, Straight Handle <b>Users:</b> Features include 2,000 user codes, 500 scheduled events & 40,000 event audit trail.	26D	Compatible w/ Corbin ED5000	\$2,754.75
ETPLS1G/26DD93	Prox Only, Straight Handle <b>Users:</b> Features include 2,000 user codes, 500 scheduled events & 40,000 event audit trail.	26D	Compatible w/ Dorma 9300	\$2,754.75
ETPLS1G/26DNS8	Prox Only, Straight Handle <b>Users:</b> Features include 2,000 user codes, 500 scheduled events & 40,000 event audit trail.	26D	Compatible w/ New Sargent 8800	\$2,754.75
ETPLS1G/26DS88	Prox Only, Straight Handle <b>Users:</b> Features include 2,000 user codes, 500 scheduled events & 40,000 event audit trail.	26D	Compatible w/ New Sargent 8800	\$2,754.75
ETPLS1G/26DV99	Prox Only, Straight Handle <b>Users:</b> Features include 2,000 user codes, 500 scheduled events & 40,000 event audit trail.	26D	Compatible w/ VonDuprin 99	\$2,754.75



## How to Order Your Trilogy Exit Lock

Below is a "How to Order" guide for the Trilogy Exit Trim products. Please follow this guide when placing orders to avoid any delay in processing your order.

All units are sold with a generic cylinder adapter installed. When you are using a specific brand of rim cylinder, you must purchase a Cylinder Adapter Kit from the chart below.

### ETPDL S1G/26DV99

#### COMPATABLE PANIC DEVICES

- V99 – VonDuprin 99(P21, Hager 4500)
- C50 – Corbin ED5000
- Y71 - Yale 7100
- D93 – Dorma 9300
- A38 – Arrow 3800
- S88 – Old Style Sargent 8800 NS8 – New Style Sargent 8888 P11 - Precision 1100
- CR8 – Cal Royal 9800
- M99 - Marks 9900

#### TYPE

- PDL Digital w/Prox
- PL Prox only
- DL Keypad only

#### HANDLE

- R-Regal
- S-Straight

#### DOOR THICKNESS

1=1 3/4" + 1/8"  
All units shipped with "1" option.

For thicker door preps, you must order extended spindle and screw kit separately.

**G= generic rim cylinder & adapter kit included in all locks**

#### FINISH

- 26D = satin chrome
- 10B = duronodic

#### CYLINDER ADAPTER KITS

You must choose one of the cylinder adapter kits below if you are using a name brand cylinder in the lock.

- ET - AL - Alarm Lock standard (Schlage C keyway)
- ET - BIC - Best IC 6 & 7 pin
- ET - S - Schlage standard rim
- ET - SIC - Schlage IC
- ET - R - Sargent standard rim
- ET - RIC - Sargent IC
- ET - Y - Yale standard rim
- ET - YIC - Yale IC 6 pin
- ET - C - Corbin standard rim
- ET - CIC - Corbin IC
- ET - M - Medeco standard rim
- ET - MIC - Medeco IC 6 & 7 pin
- ET - AR - Arrow standard rim
- ET - ARIC - Arrow IC 6 & 7 pin
- ET - AS - ASSA standard rim

Please note that Precision 2100 series will match up to the Von Duprin 99 series Trilogy. You must get a mounting plate #BP21 from Precision.

## DK3000/PDK3000 Series

Electronic digital keypad. Available in keypad only and keypad plus prox, Prox unit will read most HID cards and keyfobs.

- Wall mount :** Single gang box mounting.
- Wiring :** Unit provides flying leads for power, relays, tamper and remote Release.
- I/O Specs:** 2 form C relays 5AMP minimum contact rating. Red & green LED Indicators. 1 remote release input. Sounder and tamper.
- Power:** Operating voltage 12-24VAC/DC field selectable.



Part No.	Special Features	Finish	List Price
DK3000MB	Keypad Only	Metallic bronze	\$1,027.04
	<b>Users:</b> Holds up to 2,000 user codes, Master, Management, Supervisor & basic user. 500 event schedule, real time clock & 40,000 event audit trail.		
DK3000MS	Keypad Only	Metallic silver	\$1,027.04
	<b>Users:</b> Holds up to 2,000 user codes, Master, Management, Supervisor & basic user. 500 event schedule, real time clock & 40,000 event audit trail.		
PDK3000/10B	Keypad & Built-in HID Prox Reader	10B	\$1,937.30
	<b>Users:</b> Holds up to 2,000 user codes, Master, Management, Supervisor & basic user. 500 event schedule, real time clock & 40,000 event audit trail.		
PDK3000/26D	Keypad & Built-in HID Prox Reader	26D	\$1,937.30
	<b>Users:</b> Holds up to 2,000 user codes, Master, Management, Supervisor & basic user. 500 event schedule, real time clock & 40,000 event audit trail.		
PDK3000MB	Keypad & Built-in HID Prox Reader	Metallic bronze	\$1,706.93
	<b>Users:</b> Holds up to 2,000 user codes, Master, Management, Supervisor & basic user. 500 event schedule, real time clock & 40,000 event audit trail.		
PDK3000MS	Keypad & Built-in HID Prox Reader	Metallic silver	\$1,706.93
	<b>Users:</b> Holds up to 2,000 user codes, Master, Management, Supervisor & basic user. 500 event schedule, real time clock & 40,000 event audit trail.		



## DL6100 Series

A high-performance, keypad only, wireless cylindrical lock designed for commercial environments requiring secure, keyless access control. It integrates seamlessly into existing access systems and offers robust features without the need for extensive wiring or additional power supplies.

<b>Door Thickness:</b>	Fits 1 5/8" to 1 7/8". Other thickness, please consult factory
<b>Backset:</b>	2 3/4" (2 3/8" also available)
<b>Strike:</b>	1 1/8" x 2 3/4" T strike & 1 1/4" x 4 7/8" ASA strike included
<b>Latchbolt:</b>	UL Listed, fire rated 3 hours, 1/2" throw reversible
<b>Handing:</b>	Non-handed
<b>Power:</b>	4 C-cell batteries (included)
<b>Compliances:</b>	BHMA Certified Grade 1 heavy duty cylindrical lockset. UL listed UL Listed 10C Positive Pressure Specification. FCC Certified. ADA compliant levers
<b>Cylinder:</b>	6 pin solid brass, SC1 keyway, furnished with all key override locks. Schlage, Corbin-Russwin CL, Sargent 480 series, ASSA 65-611 & Lori cylinders can also be used with HW620 tailpiece (supplied)
<b>Interchangeable Core Models:</b>	Standard model accepts 6 & 7 pin cylinders from Best, Falcon, Arrow, KSP, Medeco Keymark & Kaba Peaks. IC core models prepped for 6 & 7 pin Yale, Medeco, Sargent, Corbin-Russwin & Schlage are also available



Part No.	Special Features	Finish	Prep	List Price
DL6100/10B	Standard Key override	10B	Standard ANSI A115 Series prep, modified by adding additional through-bolt holes	\$2,619.06
	<b>Users:</b> 5,000 pin user codes (3-6 digits), 500 - scheduled events and 35,000 event audit log			
DL6100/26D	Standard Key override	26D	Standard ANSI A115 Series prep, modified by adding additional through-bolt holes	\$2,479.06
	<b>Users:</b> 5,000 pin user codes (3-6 digits), 500 - scheduled events and 35,000 event audit log			
DL6100/26DUPGRD	Networkx DL6100 Upgrade Kit Includes Outside Housing and Inside Housing	26D	Standard ANSI A115 Series prep, modified by adding additional through-bolt holes	\$1,493.91
	<b>Users:</b> 5,000 pin user codes (3-6 digits), 500 - scheduled events and 35,000 event audit log			
DL6100IC/10B	IC Core	10B	Standard ANSI A115 Series prep, modified by adding additional through-bolt holes	\$2,727.60
	<b>Users:</b> 5,000 pin user codes (3-6 digits), 500 - scheduled events and 35,000 event audit log			
DL6100IC/26D	IC Core	26D	Standard ANSI A115 Series prep, modified by adding additional through-bolt holes	\$2,513.20
	<b>Users:</b> 5,000 pin user codes (3-6 digits), 500 - scheduled events and 35,000 event audit log			
DL6100IC/26D-C	Corbin IC Core	26D	Standard ANSI A115 Series prep, modified by adding additional through-bolt holes	\$2,538.81
	<b>Users:</b> 5,000 pin user codes (3-6 digits), 500 - scheduled events and 35,000 event audit log			
DL6100IC/26D-M	Medeco IC Core	26D	Standard ANSI A115 Series prep, modified by adding additional through-bolt holes	\$2,538.81
	<b>Users:</b> 5,000 pin user codes (3-6 digits), 500 - scheduled events and 35,000 event audit log			
DL6100IC/26D-R	Sargent IC Core	26D	Standard ANSI A115 Series prep, modified by adding additional through-bolt holes	\$2,538.81
	<b>Users:</b> 5,000 pin user codes (3-6 digits), 500 - scheduled events and 35,000 event audit log			
DL6100IC/26D-S	Schlage IC Core	26D	Standard ANSI A115 Series prep, modified by adding additional through-bolt holes	\$2,538.81
	<b>Users:</b> 5,000 pin user codes (3-6 digits), 500 - scheduled events and 35,000 event audit log			
DL6100IC/26D-Y	Yale IC Core	26D	Standard ANSI A115 Series prep, modified by adding additional through-bolt holes	\$2,538.81
	<b>Users:</b> 5,000 pin user codes (3-6 digits), 500 - scheduled events and 35,000 event audit log			

## PDL6200 Series

Wireless electronic access control solution w/ Keypad & Prox designed for commercial & institutional environments. It combines the reliability of traditional mechanical locks with the flexibility and efficiency of modern networked security systems. Uses HID II 26-37 bit format

<b>Door Thickness:</b>	Fits 1 5/8" to 1 7/8".
<b>Backset:</b>	2 3/4" (2 3/8" also available)
<b>Strike:</b>	1 1/8" x 2 3/4" T strike & 1 1/4" x 4 7/8" ASA strike included
<b>Latchbolt:</b>	UL Listed, fire rated 3 hours, 1/2" throw reversible
<b>Handing:</b>	Non-handed
<b>Power:</b>	4 C-cell batteries (included)
<b>Door prep:</b>	Standard ANSI A115 Series prep, modified by adding additional through-bolt holes
<b>Compliances:</b>	BHMA Certified Grade 1 heavy duty cylindrical lockset. UL listed UL Listed 10C Positive Pressure Specification. FCC Certified. ADA compliant levers
<b>Cylinder:</b>	6 pin solid brass, SC1 keyway, furnished with all key override locks. Schlage, Corbin-Russwin CL, Sargent 480 series, ASSA 65-611 & Lori cylinders can also be used with HW620 tailpiece (supplied)
<b>Interchangeable Core Models:</b>	Standard model accepts 6 & 7 pin cylinders from : Arrow, KSP, Medeco Keymark & Kaba Peaks. IC core models prepped for 6 & 7 pin Yale, Medeco, Sargent, Corbin-Russwin & Schlage are also available



Part No.	Special Features	Finish	Prep	List Price
PDL6200/10B	Standard Key override	10B	Standard ANSI A115 Series prep, modified by adding additional through-bolt holes	\$3,691.72
	<b>Users:</b> 5,000 pin user codes (3-6 digits), 500 - scheduled events and 35,000 event audit log			
PDL6200/10BUPGD	Component Kit To Upgrade T2 or T3 Cylindrical locks	10B	Standard ANSI A115 Series prep, modified by adding additional through-bolt holes	\$2,450.60
	<b>Users:</b> 5,000 pin user codes (3-6 digits), 500 - scheduled events and 35,000 event audit log			
PDL6200/26D	Standard Key override	26D	Standard ANSI A115 Series prep, modified by adding additional through-bolt holes	\$3,269.55
	<b>Users:</b> 5,000 pin user codes (3-6 digits), 500 - scheduled events and 35,000 event audit log			
PDL6200/19	Standard Key override	19	Standard ANSI A115 Series prep, modified by adding additional through-bolt holes	\$3,269.55
	<b>Users:</b> 5,000 pin user codes (3-6 digits), 500 - scheduled events and 35,000 event audit log			
PDL6200/26DUPGD	Component Kit To Upgrade T2 or T3 Cylindrical locks	26D	Standard ANSI A115 Series prep, modified by adding additional through-bolt holes	\$2,342.06
	<b>Users:</b> 5,000 pin user codes (3-6 digits), 500 - scheduled events and 35,000 event audit log			
PDL6200IC/10B	IC Core	10B	Standard ANSI A115 Series prep, modified by adding additional through-bolt holes	\$3,727.90
	<b>Users:</b> 5,000 pin user codes (3-6 digits), 500 - scheduled events and 35,000 event audit log			

**PDL6200 Series** (continue)



Part No.	Special Features	Finish	Prep	List Price
PDL6200IC/10B-M	Medeco IC Core	10B	Standard ANSI A115 Series prep, modified by adding additional through-bolt holes	\$3,749.61
	<b>Users:</b> 5,000 pin user codes (3-6 digits), 500 - scheduled events and 35,000 event audit log			
PDL6200IC/10B-R	Sargent IC Core	10B	Standard ANSI A115 Series prep, modified by adding additional through-bolt holes	\$3,749.61
	<b>Users:</b> 5,000 pin user codes (3-6 digits), 500 - scheduled events and 35,000 event audit log			
PDL6200IC/10B-S	Schlage IC Core	10B	Standard ANSI A115 Series prep, modified by adding additional through-bolt holes	\$3,749.61
	<b>Users:</b> 5,000 pin user codes (3-6 digits), 500 - scheduled events and 35,000 event audit log			
PDL6200IC/26D	IC Core	26D	Standard ANSI A115 Series prep, modified by adding additional through-bolt holes	\$3,295.16
	<b>Users:</b> 5,000 pin user codes (3-6 digits), 500 - scheduled events and 35,000 event audit log			
PDL6200IC/26D-C	Corbin IC Core	26D	Standard ANSI A115 Series prep, modified by adding additional through-bolt holes	\$3,316.87
	<b>Users:</b> 5,000 pin user codes (3-6 digits), 500 - scheduled events and 35,000 event audit log			
PDL6200IC/26D-M	Medeco IC Core	26D	Standard ANSI A115 Series prep, modified by adding additional through-bolt holes	\$3,316.87
	<b>Users:</b> 5,000 pin user codes (3-6 digits), 500 - scheduled events and 35,000 event audit log			
PDL6200IC/26D-R	Schlage IC Core	26D	Standard ANSI A115 Series prep, modified by adding additional through-bolt holes	\$3,316.87
	<b>Users:</b> 5,000 pin user codes (3-6 digits), 500 - scheduled events and 35,000 event audit log			
PDL6200IC/26D-S	Schlage IC Core	26D	Standard ANSI A115 Series prep, modified by adding additional through-bolt holes	\$3,316.87
	<b>Users:</b> 5,000 pin user codes (3-6 digits), 500 - scheduled events and 35,000 event audit log			
PDL6200IC/26D-Y	Yale IC Core	26D	Standard ANSI A115 Series prep, modified by adding additional through-bolt holes	\$3,316.87
	<b>Users:</b> 5,000 pin user codes (3-6 digits), 500 - scheduled events and 35,000 event audit log			
PDL6200IC7/10B-C	Corbin 7 pin IC Core	10B	Standard ANSI A115 Series prep, modified by adding additional through-bolt holes	\$3,749.61
	<b>Users:</b> 5,000 pin user codes (3-6 digits), 500 - scheduled events and 35,000 event audit log			



**PDL6200 Series** (continue)



PDL6200IC7/26D-Y	Yale 7 pin IC Core	26D	Standard ANSI A115 Series prep, modified by adding additional through-bolt holes	\$3,316.87
	<b>Users:</b> 5,000 pin user codes (3-6 digits), 500 - scheduled events and 35,000 event audit log			
PDL6275/10B	IC Cored, Regal (curved)	10B	Standard ANSI A115 Series prep, modified by adding additional through-bolt holes	\$3,727.90
	<b>Users:</b> 5,000 pin user codes (3-6 digits), 500 - scheduled events and 35,000 event audit log			
PDL6275/26D	IC Core, Regal (curved)	26D	Standard ANSI A115 Series prep, modified by adding additional through-bolt holes	\$3,305.73
	<b>Users:</b> 5,000 pin user codes (3-6 digits), 500 - scheduled events and 35,000 event audit log			
PDL6275IC/10B-S	Schlage IC Core, Regal (curved)	10B	Standard ANSI A115 Series prep, modified by adding additional through-bolt holes	\$3,785.79
	<b>Users:</b> 5,000 pin user codes (3-6 digits), 500 - scheduled events and 35,000 event audit log			
PDL6275IC/26D	IC Core, Regal (curved)	26D	Standard ANSI A115 Series prep, modified by adding additional through-bolt holes	\$3,338.58
	<b>Users:</b> 5,000 pin user codes (3-6 digits), 500 - scheduled events and 35,000 event audit log			
PDL6275IC/26D-R	Sargent IC Core, Regal (curved)	26D	Standard ANSI A115 Series prep, modified by adding additional through-bolt holes	\$3,360.29
	<b>Users:</b> 5,000 pin user codes (3-6 digits), 500 - scheduled events and 35,000 event audit log			
PDL6275IC/26D-S	Schlage IC Core, Regal (curved)	26D	Standard ANSI A115 Series prep, modified by adding additional through-bolt holes	\$3,360.29
	<b>Users:</b> 5,000 pin user codes (3-6 digits), 500 - scheduled events and 35,000 event audit log			
PDL6275IC/26D-Y	Yale IC Core, Regal (curved)	26D	Standard ANSI A115 Series prep, modified by adding additional through-bolt holes	\$3,360.29
	<b>Users:</b> 5,000 pin user codes (3-6 digits), 500 - scheduled events and 35,000 event audit log			

## PL6200 Series

A high-performance, prox only, wireless cylindrical lock designed for commercial environments requiring secure, keyless access control. It integrates seamlessly into existing access systems and offers robust features without the need for extensive wiring or additional power supplies. Uses HID II 26-37 bit format

- Door Thickness:** Fits 1 5/8" to 1 7/8"
- Backset:** 2 3/4" (2 3/8" also available)
- Strike:** 1 1/8" x 2 3/4" T strike & 1 1/4" x 4 7/8" ASA strike included
- Latchbolt:** UL Listed, fire rated 3 hours, 1/2" throw reversible
- Handing:** Non-handed
- Power:** 4 C-cell batteries (included)
- Door prep:** Standard ANSI A115 Series prep, modified by adding additional through-bolt holes
- Compliances:** BHMA Certified Grade 1 heavy duty cylindrical lockset. UL listed UL Listed 10C Positive Pressure Specification. FCC Certified . ADA compliant levers
- Cylinder:** 6 pin solid brass, SC1 keyway, furnished with all key override locks. Schlage, Corbin-Russwin CL, Sargent 480 series, ASSA 65-611 & Lori cylinders can also be used with HW620 tailpiece (supplied)
- Interchangeable Core Models:** Standard model accepts 6 & 7 pin cylinders from Arrow, KSP, Medeco Keymark & Kaba Peaks. IC core models prepped for 6 & 7 pin Yale, Medeco, Sargent, Corbin-Russwin & Schlage are also available



Part No.	Special Features	Finish	Prep	List Price
PL6200/10B	Standard Key override	10B	Standard ANSI A115 Series prep, modified by adding additional through-bolt holes	\$2,450.60
	<b>Users:</b> 5,000 HID - Proximity cards. 500 scheduled events and 35,000 event audit log.			
PL6200/26D	Standard Key override	26D	Standard ANSI A115 Series prep, modified by adding additional through-bolt holes	\$3,269.55
	<b>Users:</b> 5,000 HID - Proximity cards. 500 scheduled events and 35,000 event audit log.			
PL6200IC/26D	IC Core	26D	Standard ANSI A115 Series prep, modified by adding additional through-bolt holes	\$3,295.16
	<b>Users:</b> 5,000 HID - Proximity cards. 500 scheduled events and 35,000 event audit log.			
PL6200IC/26D-M	Medeco IC Core	26D	Standard ANSI A115 Series prep, modified by adding additional through-bolt holes	\$3,316.87
	<b>Users:</b> 5,000 HID - Proximity cards. 500 scheduled events and 35,000 event audit log.			
PL6200IC/26D-S	Schlage IC Core	26D	Standard ANSI A115 Series prep, modified by adding additional through-bolt holes	\$3,316.87
	<b>Users:</b> 5,000 HID - Proximity cards. 500 scheduled events and 35,000 event audit log.			
PL6200IC/26D-Y	Yale IC Core	26D	Standard ANSI A115 Series prep, modified by adding additional through-bolt holes	\$3,316.87
	<b>Users:</b> 5,000 HID - Proximity cards. 500 scheduled events and 35,000 event audit log.			
PL6200IC/26D-C	Corbin IC Core	26D	Standard ANSI A115 Series prep, modified by adding additional through-bolt holes	\$3,316.87
	<b>Users:</b> 5,000 HID - Proximity cards. 500 scheduled events and 35,000 event audit log.			
PL6200IC/26D-R	Sargent IC Core	26D	Standard ANSI A115 Series prep, modified by adding additional through-bolt holes	\$3,316.87
	<b>Users:</b> 5,000 HID - Proximity cards. 500 scheduled events and 35,000 event audit log.			

## PDL6600 Series

Prox and Digital mortise lock. Uses HID II 26-27 bit format.

- Door Thickness:** Fits 1 5/8" to 1 7/8" (4.46cm). Backset:
- Strike:** 1 1/4" x 4 7/8" strike included
- Handing:** Specify RH or LH when ordering, lock is reversible in the field
- Power:** 4 C- cell batteries (included)
- Keypad:** All metal, 12 button. Basic functions programmed through keypad.
- Compliances:** Steelcase lock body meets BHMA specifications for Grade 1 locks. UL listed to the 10C Positive Pressure Specification. FCC Certified. ADA compliant levers
- Functions:** Classroom function feature stainless steel latchbolt with 3/4" (1.91cm) projection & deadlocking latch.
- Cylinder:** 1 3/8" (3.5cm) mortise cylinder supplied. Will Accept 1 3/8" to 1 1/2" (3.5 - 3.82cm) mortise Cylinder. Classroom function supplied with straight Cam.
- Cams:** Cams for other manufacturer's cylinders are available  
See "Mortise Lock accessories" for part numbers & Manufacturers
- Note:** PDL6600- Request to exit (REX); real time when integrated with CIC, Lenel, Stanley B.A.S.I.S. When used on Networkx; sound at door, will record on audit trail. Must pull audit log to view.



Part No.	Special Features	Finish	Prep	List Price
PDL6600/10BUPGD	Component Kit to upgrade T2 or T3 Mortise	10B	Standard ANSI A115 mortise prep, modified by adding additional through-bolt holes	\$2,802.32
<b>Users:</b> 5,000 PIN user codes (3-6 digits) and HID - Proximity cards. 500 scheduled events and 35,000 event audit log.				
PDL6600/26DUPGD	Component Kit to upgrade T2 or T3 Mortise	26D	Standard ANSI A115 mortise prep, modified by adding additional through-bolt holes	\$2,693.78
<b>Users:</b> 5,000 PIN user codes (3-6 digits) and HID - Proximity cards. 500 scheduled events and 35,000 event audit log.				
PDL6600CRL/10B	Straight lever classroom function Left Hand W/ Door position switch	10B	Standard ANSI A115 mortise prep, modified by adding additional through-bolt holes	\$3,534.19
<b>Users:</b> 5,000 PIN user codes (3-6 digits) and HID - Proximity cards. 500 scheduled events and 35,000 event audit log.				
PDL6600CRL/26D	Straight lever classroom function Left Hand W/ Door position switch	26D	Standard ANSI A115 mortise prep, modified by adding additional through-bolt holes	\$3,419.80
<b>Users:</b> 5,000 PIN user codes (3-6 digits) and HID - Proximity cards. 500 scheduled events and 35,000 event audit log.				
PDL6600CRR/10B	Straight lever classroom function Right Hand W/ Door position switch	10B	Standard ANSI A115 mortise prep, modified by adding additional through-bolt holes	\$3,534.19
<b>Users:</b> 5,000 PIN user codes (3-6 digits) and HID - Proximity cards. 500 scheduled events and 35,000 event audit log.				
PDL6600CRR/26D	Straight lever classroom function right Hand W/ Door position switch	26D	Standard ANSI A115 mortise prep, modified by adding additional through-bolt holes	\$3,419.80
<b>Users:</b> 5,000 PIN user codes (3-6 digits) and HID - Proximity cards. 500 scheduled events and 35,000 event audit log.				
PDL6675CRL/10B	Regal (curved) lever classroom function left Hand W/ Door position switch	10B	Standard ANSI A115 mortise prep, modified by adding additional through-bolt holes	\$3,577.60
<b>Users:</b> 5,000 PIN user codes (3-6 digits) and HID - Proximity cards. 500 scheduled events and 35,000 event audit log.				



### PDL6600 Series (continue)



PDL6675CRL/26D	Regal (curved) lever classroom function Left Hand W/ Door position switch	26D	Standard ANSI A115 mortise prep, modified by adding additional through-bolt holes	\$3,463.21
	<b>Users:</b> 5,000 PIN user codes (3-6 digits) and HID - Proximity cards. 500 scheduled events and 35,000 event audit log.			
PDL6675CRR/10B	Regal (curved) lever classroom function right Hand W/ Door position switch	10B	Standard ANSI A115 mortise prep, modified by adding additional through-bolt holes	\$3,577.60
	<b>Users:</b> 5,000 PIN user codes (3-6 digits) and HID - Proximity cards. 500 scheduled events and 35,000 event audit log.			
PDL6675CRR/26D	Regal (curved) lever classroom function right Hand W/ Door position switch	26D	Standard ANSI A115 mortise prep, modified by adding additional through-bolt holes	\$3,463.21
	<b>Users:</b> 5,000 PIN user codes (3-6 digits) and HID - Proximity cards. 500 scheduled events and 35,000 event audit log.			
PL6600CRL/26D	Prox Only, Straight lever classroom function left Hand W/ Door position switch	26D	Standard ANSI A115 mortise prep, modified by adding additional through-bolt holes	\$3,419.80
	<b>Users:</b> 5,000 PIN user codes (3-6 digits) and HID - Proximity cards. 500 scheduled events and 35,000 event audit log.			
PL6600CRR/26D	Prox Only, Straight lever classroom function right Hand W/ Door position switch	26D	Standard ANSI A115 mortise prep, modified by adding additional through-bolt holes	\$3,419.80
	<b>Users:</b> 5,000 PIN user codes (3-6 digits) and HID - Proximity cards. 500 scheduled events and 35,000 event audit log.			

## PDL/PL8200 Series

Prox and/or digital cylindrical lock w/ a 13.56 MHz iClass smart card proximity reader. 26-27 bit format supported

- Door Thickness:** Fits 1 5/8" to 1 7/8". Other thickness, please consult factory
- Backset:** 2 3/4" (2 3/8" also available)
- Strike:** 1 1/8" x 2 3/4" T strike & 1 1/4" x 4 7/8" ASA strike included
- Latchbolt:** UL Listed, fire rated 3 hours, 1/2" throw reversible
- Handing:** Non-handed
- Power:** 4 C-cell batteries (included)
- Keypad:** All metal, 12 button. Basic functions programmed through the keypad.
- Compliances:** BHMA Certified Grade 1 heavy duty cylindrical lockset. UL listed UL Listed 10C Positive Pressure Specification. FCC Certified . ADA compliant levers
- Cylinder:** 6 pin solid brass, SC1 keyway, furnished with all key override locks. Schlage, Corbin-Russwin CL, Sargent 480 series, ASSA 65-611 & Lori cylinders can also be used with HW620 tailpiece (supplied)
- Interchangeable Core Models:** Standard model accepts 6 & 7 pin cylinders from Best, Falcon, Arrow, KSP, Medeco Keymark & Kaba Peaks. IC core models prepped for 6 & 7 pin Yale, Medeco, Sargent, Corbin-Russwin & Schlage are also available



Part No.	Special Features	Finish	Prep	List Price
PDL8200-WUSD	Local Classroom Lockdown	26D	Standard ANSI A115 Series prep, modified by adding additional through-bolt holes	\$3,517.77
	<b>Users:</b> 5,000 PIN user codes (3-6 digits), 500 scheduled events and 35,000 event audit log.			
PDL8200/10B	Standard Key override	10B	Standard ANSI A115 Series prep, modified by adding additional through-bolt holes	\$3,553.94
	<b>Users:</b> 5,000 PIN user codes (3-6 digits), 500 scheduled events and 35,000 event audit log.			
PDL8200/10BUPGD	Component Kit to upgrade T2 or T3 Cylindrical locks	10B	Standard ANSI A115 Series prep, modified by adding additional through-bolt holes	\$2,561.98
	<b>Users:</b> 5,000 PIN user codes (3-6 digits), 500 scheduled events and 35,000 event audit log.			
PDL8200/26D	Standard Key override	26D	Standard ANSI A115 Series prep, modified by adding additional through-bolt holes	\$3,445.41
	<b>Users:</b> 5,000 PIN user codes (3-6 digits), 500 scheduled events and 35,000 event audit log.			
PDL8200/26DUPGD	Component Kit to upgrade T2 or T3 Cylindrical locks	26D	Standard ANSI A115 Series prep, modified by adding additional through-bolt holes	\$2,453.44
	<b>Users:</b> 5,000 PIN user codes (3-6 digits), 500 scheduled events and 35,000 event audit log.			
PDL8200IC/10B	IC Core	10B	Standard ANSI A115 Series prep, modified by adding additional through-bolt holes	\$3,581.28
	<b>Users:</b> 5,000 PIN user codes (3-6 digits), 500 scheduled events and 35,000 event audit log.			



**PDL/PL8200 Series** (continue)



Part No.	Special Features	Finish	Prep	List Price
PDL8200IC/10B-S	Schlage IC Core	10B	Standard ANSI A115 Series prep, modified by adding additional through-bolt holes	\$3,619.07
	<b>Users:</b> 5,000 PIN user codes (3-6 digits), 500 scheduled events and 35,000 event audit log.			
PDL8200IC/26D	IC Core	26D	Standard ANSI A115 Series prep, modified by adding additional through-bolt holes	\$3,472.72
	<b>Users:</b> 5,000 PIN user codes (3-6 digits), 500 scheduled events and 35,000 event audit log.			
PDL8200IC/26D-C	Corbin IC Core	26D	Standard ANSI A115 Series prep, modified by adding additional through-bolt holes	\$3,494.43
	<b>Users:</b> 5,000 PIN user codes (3-6 digits), 500 scheduled events and 35,000 event audit log.			
PDL8200IC/26D-R	Sargent IC Core	26D	Standard ANSI A115 Series prep, modified by adding additional through-bolt holes	\$3,494.43
	<b>Users:</b> 5,000 PIN user codes (3-6 digits), 500 scheduled events and 35,000 event audit log.			
PDL8200IC/26D-S	Schlage IC Core	26D	Standard ANSI A115 Series prep, modified by adding additional through-bolt holes	\$3,494.43
	<b>Users:</b> 5,000 PIN user codes (3-6 digits), 500 scheduled events and 35,000 event audit log.			
PDL8200ICWUSD-S	Local Classroom Lockdown, Schlage IC Core	26D	Standard ANSI A115 Series prep, modified by adding additional through-bolt holes	\$3,566.79
	<b>Users:</b> 5,000 PIN user codes (3-6 digits), 500 scheduled events and 35,000 event audit log.			
PDL8200IC726D-C	Corbin 7 pin IC Core	26D	Standard ANSI A115 Series prep, modified by adding additional through-bolt holes	\$3,494.43
	<b>Users:</b> 5,000 PIN user codes (3-6 digits), 500 scheduled events and 35,000 event audit log.			
PDL8200WUSD/10B	Local Classroom Lockdown	10B	Standard ANSI A115 Series prep, modified by adding additional through-bolt holes	\$3,626.32
	<b>Users:</b> 5,000 PIN user codes (3-6 digits), 500 scheduled events and 35,000 event audit log.			
PL8200/26D	Prox Only, Standard Key override	26D	Standard ANSI A115 Series prep, modified by adding additional through-bolt holes	\$3,445.40
	<b>Users:</b> 500 scheduled events and 35,000 event audit log.			
PL8200IC/26D	Prox Only IC Core	26D	Standard ANSI A115 Series prep, modified by adding additional through-bolt holes	\$3,472.72
	<b>Users:</b> 500 scheduled events and 35,000 event audit log.			

## PDL8600 Series

iClass Prox and Digital mortise lock

- Door Thickness:** Fits 1 5/8" to 1 7/8"
- Backset:** 2 3/4" standard
- Strike:** 1 1/4" x 4 7/8" strike included
- Handing:** Specify RH or LH when ordering, lock is reversible in the field
- Power:** 4 C- cell batteries (included)
- Keypad:** All metal, 12 button. Basic functions programmed through keypad.
- Compliances:** Steelcase lock body meets BHMA specifications for Grade 1 locks. UL listed to the 10C Positive Pressure Specification. FCC Certified. ADA compliant levers
- Functions:** Classroom function feature stainless steel latchbolt with 3/4" (1.91cm) projection and deadlocking latch.
- Cylinder:** 1 3/8" (3.5cm) mortise cylinder supplied. Will accept 1 3/8" to 1 1/2" (3.5 – 3.82cm) mortise Cylinder. Classroom function supplied with straight Cam.
- Cams:** Cams for other manufacturer's cylinders are available See "Mortise Lock accessories" for part numbers & Manufacturers
- \*Note:** Request to exit (REX); real time when integrated with CIC, Lenel, Stanley B.A.S.I.S.  
When used on Networkx; sound at door, will record on audit trail. Must pull audit log to view.

Part No.	Special Features	Finish	Prep	List Price
PDL8600CRL/26D	Straight lever classroom function Left Hand	26D	Standard ANSI A115 mortise prep, modified by adding additional through-bolt holes	\$3,595.65
	<b>Users:</b> 5,000 PIN user codes (3-6 digits) with a 13.56 - MHz iClass smart card proximity reader. 500 scheduled events and 35,000 event audit log			
PDL8600CRR/26D	Straight lever classroom function Right Hand	26D	Standard ANSI A115 mortise prep, modified by adding additional through-bolt holes	\$3,595.65
	<b>Users:</b> 5,000 PIN user codes (3-6 digits) with a 13.56 - MHz iClass smart card proximity reader. 500 scheduled events and 35,000 event audit log			

## TRILOGY NETWORKX EXIT TRIM Series

Battery operated Trilogy Networkx outside trim works with Marks M9900, Von Duprin 99, Corbin ED5000, Yale 7100, Dorma 9300, Arrow 3800, Sargent 8888, Precision 1100, 2100 & Cal Royal 9800, Hager 4500 series panic devices. Available in DL series (keypad) or PDL (prox/keypad) formats.

- Door Thickness:** Standard model fits 1 5/8" to 1 7/8"
- Cylinder:** Uses standard rim cylinder to operate key override function. Will accept 6 or 7 pin interchangeable core cylinders – see below.
- Handing:** Non-handed
- Power:** 4 C-cell batteries (included) mounted on inside of door.
- Keypad:** Weather-resistant all metal, 12 button. Basic functions Programmable through the keypad. PDL version proximity antenna housing molded of ultra high strength, impact resistant Lexan® Proximity version uses HID II 26-37 bit format



Part No.	Special Features	Finish	Prep	List Price
ETDLNS1G/10BC50	Keypad Only, Straight Handle	10B	Compatible w/ Corbin ED5000	\$2,531.62
	<b>Users:</b> Features include 5,000 user codes, 500 scheduled events and 35,000 event audit log			
ETDLNS1G/10BD93	Keypad Only, Straight Handle	10B	Compatible w/ Dorma 9300	\$2,531.62
	<b>Users:</b> Features include 5,000 user codes, 500 scheduled events and 35,000 event audit log			
ETDLNS1G/10BNS8	Keypad Only, Straight Handle	10B	Compatible w/ New Sargent 8800	\$2,531.62
	<b>Users:</b> Features include 5,000 user codes, 500 scheduled events and 35,000 event audit log			
ETDLNS1G/10BS88	Keypad Only, Straight Handle	10B	Compatible w/ Sargent 8800	\$2,531.62
	<b>Users:</b> Features include 5,000 user codes, 500 scheduled events and 35,000 event audit log			
ETDLNS1G/10BV99	Keypad Only, Straight Handle	10B	Compatible w/ VonDuprin 99	\$2,434.66
	<b>Users:</b> Features include 5,000 user codes, 500 scheduled events and 35,000 event audit log			
ETDLNS1G/26DCR8	Keypad Only, Straight Handle	26D	Compatible w/ Cal Royal 9800	\$2,434.66
	<b>Users:</b> Features include 5,000 user codes, 500 scheduled events and 35,000 event audit log			
ETDLNS1G/26DC50	Keypad Only, Straight Handle	26D	Compatible w/ Corbin ED5000	\$2,434.66
	<b>Users:</b> Features include 5,000 user codes, 500 scheduled events and 35,000 event audit log			
ETDLNS1G/26DD93	Keypad Only, Straight Handle	26D	Compatible w/ Dorma 9300	\$2,434.66
	<b>Users:</b> Features include 5,000 user codes, 500 scheduled events and 35,000 event audit log			

## TRILOGY NETWORKX EXIT TRIM Series (continue)



ETDLNS1G/26DM99	Keypad Only, Straight Handle	26D	Compatible w/ Marks M9900	\$2,434.66
	<b>Users:</b> Features include 5,000 user codes, 500 scheduled events and 35,000 event audit log			
ETDLNS1G/26DNS8	Keypad Only, Straight Handle	26D	Compatible w/ New Sargent 8800	\$2,434.66
	<b>Users:</b> Features include 5,000 user codes, 500 scheduled events and 35,000 event audit log			
ETDLNS1G/26DP11	Keypad Only, Straight Handle	26D	Compatible w/ Precision 1100	\$2,434.66
	<b>Users:</b> Features include 5,000 user codes, 500 scheduled events and 35,000 event audit log			
ETDLNS1G/26DS88	Keypad Only, Straight Handle	26D	Compatible w/ Sargent 8800	\$2,434.66
	<b>Users:</b> Features include 5,000 user codes, 500 scheduled events and 35,000 event audit log			
ETDLNS1G/26DV99	Keypad Only, Straight Handle	26D	Compatible w/ VonDuprin 99	\$2,434.66
	<b>Users:</b> Features include 5,000 user codes, 500 scheduled events and 35,000 event audit log			
ETDLNS1G/26DY71	Keypad Only, Straight Handle	26D	Compatible w/ Yale 7100	\$2,434.66
	<b>Users:</b> Features include 5,000 user codes, 500 scheduled events and 35,000 event audit log			
ETPDNSRX10BCR8	Digital w/ Prox, Straight Handle, Request to Exit	10B	Compatible w/ Cal Royal 9800	\$3,210.77
	<b>Users:</b> Features include 5,000 user codes, 500 scheduled events and 35,000 event audit log			
ETPDNSRX10BC50	Digital w/ Prox, Straight Handle, Request to Exit	10B	Compatible w/ Corbin ED5000	\$3,210.77
	<b>Users:</b> Features include 5,000 user codes, 500 scheduled events and 35,000 event audit log			
ETPDNSRX10BD93	Digital w/ Prox, Straight Handle, Request to Exit	10B	Compatible w/ Dorma 9300	\$3,210.77
	<b>Users:</b> Features include 5,000 user codes, 500 scheduled events and 35,000 event audit log			
ETPDNSRX10BM99	Digital w/ Prox, Straight Handle, Request to Exit	10B	Compatible w/ Marks M9900	\$3,210.77
	<b>Users:</b> Features include 5,000 user codes, 500 scheduled events and 35,000 event audit log			
ETPDNSRX10BNS8	Digital w/ Prox, Straight Handle, Request to Exit	10B	Compatible w/ New Sargent 8800	\$3,210.77
	<b>Users:</b> Features include 5,000 user codes, 500 scheduled events and 35,000 event audit log			
ETPDNSRX10BP11	Digital w/ Prox, Straight Handle, Request to Exit	10B	Compatible w/ Precision 1100	\$3,210.77
	<b>Users:</b> Features include 5,000 user codes, 500 scheduled events and 35,000 event audit log			

## TRILOGY NETWORKX EXIT TRIM Series (continue)



Part No.	Special Features	Finish	Prep	List Price
ETPDNSRX10BS88	Digital w/ Prox, Straight Handle, Request to Exit	10B	Compatible w/ Sargent 8800	\$3,210.77
	<b>Users:</b> Features include 5,000 user codes, 500 scheduled events and 35,000 event audit log			
ETPDNSRX10BV99	Digital w/ Prox, Straight Handle, Request to Exit	10B	Compatible w/ VonDuprin 99	\$3,210.77
	<b>Users:</b> Features include 5,000 user codes, 500 scheduled events and 35,000 event audit log			
ETPDNSRX10BY71	Digital w/ Prox, Straight Handle, Request to Exit	10B	Compatible w/ Yale 7100	\$3,210.77
	<b>Users:</b> Features include 5,000 user codes, 500 scheduled events and 35,000 event audit log			
ETPDNSRX26DCR8	Digital w/ Prox, Straight Handle, Request to Exit	26D	Compatible w/ Cal Royal 9800	\$3,102.23
	<b>Users:</b> Features include 5,000 user codes, 500 scheduled events and 35,000 event audit log			
ETPDNSRX26DC50	Digital w/ Prox, Straight Handle, Request to Exit	26D	Compatible w/ Corbin ED5000	\$3,102.23
	<b>Users:</b> Features include 5,000 user codes, 500 scheduled events and 35,000 event audit log			
ETPDNSRX26DD93	Digital w/ Prox, Straight Handle, Request to Exit	26D	Compatible w/ Dorma 9300	\$3,102.23
	<b>Users:</b> Features include 5,000 user codes, 500 scheduled events and 35,000 event audit log			
ETPDNSRX26DM99	Digital w/ Prox, Straight Handle, Request to Exit	26D	Compatible w/ Marks M9900	\$3,102.23
	<b>Users:</b> Features include 5,000 user codes, 500 scheduled events and 35,000 event audit log			
ETPDNSRX26DNS8	Digital w/ Prox, Straight Handle, Request to Exit	26D	Compatible w/ New Sargent 8800	\$3,102.23
	<b>Users:</b> Features include 5,000 user codes, 500 scheduled events and 35,000 event audit log			
ETPDNSRX26DP11	Digital w/ Prox, Straight Handle, Request to Exit	26D	Compatible w/ Precision 1100	\$3,102.23
	<b>Users:</b> Features include 5,000 user codes, 500 scheduled events and 35,000 event audit log			
ETPDNSRX26DS88	Digital w/ Prox, Straight Handle, Request to Exit	26D	Compatible w/ Sargent 8800	\$3,102.23
	<b>Users:</b> Features include 5,000 user codes, 500 scheduled events and 35,000 event audit log			
ETPDNSRX26DV99	Digital w/ Prox, Straight Handle, Request to Exit	26D	Compatible w/ VonDuprin 99	\$3,102.23
	<b>Users:</b> Features include 5,000 user codes, 500 scheduled events and 35,000 event audit log			
ETPDNSRX19M99	Digital w/ Prox, Straight Handle, Request to Exit	26D	Compatible w/ Marks M9900	\$3,102.23
	<b>Users:</b> Features include 5,000 user codes, 500 scheduled events and 35,000 event audit log			

## TRILOGY NETWORKX EXIT TRIM Series (continue)



ETPDNSRX26DY71	Digital w/ Prox, Straight Handle, Request to Exit	26D	Compatible w/ Yale 7100	\$3,102.23
	<b>Users:</b> Features include 5,000 user codes, 500 scheduled events and 35,000 event audit log			
ETPDNISRX-WUSD	Digital w/ Prox, iClass Reader, Straight Handle, Request to Exit	26D	Local Classroom Lockdown	\$3,561.66
	<b>Users:</b> Features include 5,000 user codes, 500 scheduled events and 35,000 event audit log			
ETPDNISRXWSD10B	Digital w/ Prox, iClass Reader, Straight Handle, Request to Exit	10B	Local Classroom Lockdown	\$3,670.20
	<b>Users:</b> Features include 5,000 user codes, 500 scheduled events and 35,000 event audit log			
ETPDNISRX10BV99	Digital w/ Prox, iClass Reader, Straight Handle, Request to Exit	10B	Compatible w/ VonDuprin 99	\$3,662.96
	<b>Users:</b> Features include 5,000 user codes, 500 scheduled events and 35,000 event audit log			
ETPDNISRX26DC50	Digital w/ Prox, iClass Reader, Straight Handle, Request to Exit	26D	Compatible w/ Corbin ED5000	\$3,272.96
	<b>Users:</b> Features include 5,000 user codes, 500 scheduled events and 35,000 event audit log			
ETPDNISRX26DM99	Digital w/ Prox, iClass Reader, Straight Handle, Request to Exit	26D	Compatible w/ Marks M9900	\$3,272.96
	<b>Users:</b> Features include 5,000 user codes, 500 scheduled events and 35,000 event audit log			
ETPDNISRX26DNS8	Digital w/ Prox, iClass Reader, Straight Handle, Request to Exit	26D	Compatible w/ New Sargent 8800	\$3,272.96
	<b>Users:</b> Features include 5,000 user codes, 500 scheduled events and 35,000 event audit log			
ETPDNISRX26DS88	Digital w/ Prox, iClass Reader, Straight Handle, Request to Exit	26D	Compatible w/ Sargent 8800	\$3,272.96
	<b>Users:</b> Features include 5,000 user codes, 500 scheduled events and 35,000 event audit log			
ETPDNISRX26DY71	Digital w/ Prox, iClass Reader, Straight Handle, Request to Exit	26D	Compatible w/ Yale 7100	\$3,272.96
	<b>Users:</b> Features include 5,000 user codes, 500 scheduled events and 35,000 event audit log			
ETPLNISRX26DV99	Prox Only, iClass Reader, Straight Handle, Request to Exit	26D	Compatible w/ VonDuprin 99	\$3,272.97
	<b>Users:</b> Features include 5,000 user codes, 500 scheduled events and 35,000 event audit log			
ETPLNS1G/26DNS8	Prox Only, Straight Handle	26D	Compatible w/ New Sargent 8800	\$3,015.16
	<b>Users:</b> Features include 5,000 user codes, 500 scheduled events and 35,000 event audit log			
ETPLNS1G/26DS88	Prox Only, Straight Handle	26D	Compatible w/ New Sargent 8800	\$3,015.16
	<b>Users:</b> Features include 5,000 user codes, 500 scheduled events and 35,000 event audit log			

## TRILOGY NETWORKX EXIT TRIM Series (continue)



Part No.	Special Features	Finish	Prep	List Price
ETPLNS1G/26DV99	Prox Only, Straight Handle	26D	Compatible w/ VonDuprin 99	\$3,015.16
	<b>Users:</b> Features include 5,000 user codes, 500 scheduled events and 35,000 event audit log			
ETPLNS1G/26DY71	Prox Only, Straight Handle	26D	Compatible w/ Yale 7100	\$3,015.16
	<b>Users:</b> Features include 5,000 user codes, 500 scheduled events and 35,000 event audit log			
ETPLNSRX26DV99	Prox Only, Straight Handle, Request to Exit	26D	Compatible w/ VonDuprin 99	\$3,102.23
	<b>Users:</b> Features include 5,000 user codes, 500 scheduled events and 35,000 event audit log			
ETPLNSRX26DY71	Prox Only, Straight Handle, Request to Exit	26D	Compatible w/ Yale 7100	\$3,102.23
	<b>Users:</b> Features include 5,000 user codes, 500 scheduled events and 35,000 event audit log			
ETPLNSRX26DM99	Prox Only, Straight Handle, Request to Exit	26D	Compatible w/ Marks M9900	\$3,102.23
	<b>Users:</b> Features include 5,000 user codes, 500 scheduled events and 35,000 event audit log			
ETDLNS1G26DM99K	Keypad only, Straight Handle, M99 kit	26D	Compatible w/ Marks M9900	\$3,158.57
	<b>Users:</b> Features include 5,000 user codes, 500 scheduled events and 35,000 event audit log			
ETPDNSRX26DM99K	Digital w/ Prox, Straight Handle, Request to Exit, M99 Kit	26D	Compatible w/ Marks M9900	\$3,739.07
	<b>Users:</b> Features include 5,000 user codes, 500 scheduled events and 35,000 event audit log			



## How to Order Your Trilogy Networkx Exit Lock

Below is a "How to Order" guide for the Trilogy Exit Trim products. Please follow this guide when placing orders to avoid any delay in processing your order.

All units are sold with a generic cylinder adapter installed. When you are using a specific brand of rim cylinder, you must purchase a Cylinder Adapter Kit from the chart below.

### ETPDNS1G/26DV99

**TYPE**  
 PDN Digital w/Prox  
 PLN Prox only  
 DLN Keypad only

**HANDLE**  
 R-Regal  
 S-Straight

**DOOR THICKNESS**  
 1=1 3/4" + 1/8"  
**All units shipped with "1" option.**  
**For thicker door preps, you must order extended spindle and screw kit separately.**

G= generic rim  
 Cylinder & adapter kit included in all locks

**COMPATABLE PANIC DEVICES**  
 V99 – VonDuprin 99(P21, Hager 4500)  
 C50 – Corbin ED5000  
 Y71 - Yale 7100  
 D93 – Dorma 9300  
 A38 – Arrow 3800  
 S88 – Old Style Sargent 8800 NS8 –  
 New Style Sargent 8888 P11 - Precision 1100  
 CR8 – Cal Royal 9800  
 M99 - Marks 9900

**FINISH**  
 26D = satin chrome  
 10B = duronodic

**Please note that Precision 2100 series will match up to the Von Duprin 99 series Trilogy. You must get a mounting plate #BP21 from Precision.**

**CYLINDER ADAPTER KITS**  
 You must choose one of the cylinder adapter kits below if you are using a name brand cylinder in the lock.

ET - AL	- Alarm Lock standard (Schlage C keyway)
ET - BIC	- Best IC 6 & 7 pin
ET - S	- Schlage standard rim
ET - SIC	- Schlage IC
ET - R	- Sargent standard rim
ET - RIC	- Sargent IC
ET - Y	-Yale standard rim
ET - YIC	-Yale IC 6 pin
ET - C	- Corbin standard rim
ET - CIC	- Corbin IC
ET - M	- Medeco standard rim
ET - MIC	- Medeco IC 6 & 7 pin
ET - AR	- Arrow standard rim
ET - ARIC	- Arrow IC 6 & 7 pin
ET - AS	- ASSA standard rim

## TRILOGY NETWORKX WIRELESS KEYPADS AND NETPANEL

Trilogy Networkx Wireless Keypads and Netpanel combine to provide the ideal wireless keypad solution for use with mag locks, strikes and electrified exit devices in a smart access system with advanced features and functions

### Networkx Keypads NETDK / NETPDK

**Power Requirements:** 12VDC supplied by NETWORKXPANEL  
**Idle Current:** 10mA  
**Maximum Wire Length:** 200 feet (61m)  
**Proximity Card Formats Supported:** HID standard 26-37 bit format (for use with the model NETPDK only)

### Networkx Panel NETWORKXPANEL

**Input Power:** 16.5VAC via Class 2 Plug-In 50VA Transformer (supplied model TRF-14)  
**Maximum Lock Power Output Current:** 1.5A @12VDC  
**Maximum Wiegand Power Output Current:** 250mA @ 12VDC  
**Maximum Wiegand Red and Green LED Current:** 20mA each output  
**Maximum Sounder Current:** 100mA  
**Maximum Keypad Power Output Current:** 200mA @ 12VDC  
**Primary and Secondary Relays:** SPDT Form C, N/O, N/C 8A @ 30VAC or VDC  
**Supplied Backup Battery:** Sealed Lead Acid 4AH  
**Battery Backup Time:** Approximately 2 hours at full load

**Note:** In order for NETDK OR NETPDK to operate you MUST include a NETWORKXPANEL NETDK/NETPDK readers to not work with MVP Access, Air Access or MVP EZ. See pg. 65



Part No.	Special Features	Finish	List Price
NETDK/10B	Digital wireless wall mounted keypad only	10B	\$527.57
	<b>Users:</b> 5000 users with 3-6 digit PINs, 35K event log		
NETDK/26D	Digital wireless wall mounted keypad only	26D	\$527.57
	<b>Users:</b> 5000 users with 3-6 digit PINs, 35K event log		
NETDKPAK/10B	Digital wireless wall mounted keypad kit, includes wall mounted reader, control panel w/door position switch with RX, remote release, battery backup and plug in transformer.	10B	\$1,499.37
	<b>Users:</b> 5000 users with 3-6 digit PINs, 35K event log		
NETDKPAK/26D	Digital wireless wall mounted keypad kit, includes wall mounted reader, control panel w/door position switch with RX, remote release, battery backup and plug in transformer.	26D	\$1,499.37
	<b>Users:</b> 5000 users with 3-6 digit PINs, 35K event log		
NETPDK/10B	Digital & Prox wireless wall mounted keypad only	10B	\$1,080.74
	<b>Users:</b> 5000 users with 3-6 digit PINs or HID® ID cards, 35K event log		
NETPDK/26D	Digital & Prox wireless wall mounted keypad only	26D	\$1,080.74
	<b>Users:</b> 5000 users with 3-6 digit PINs or HID® ID cards, 35K event log		
NETPDKPAK/10B	Digital & HID wireless wall mounted keypad kit, includes wall mounted reader, control panel w/door position switch with RX, remote release, battery backup and plug in transformer.	10B	\$2,054.24
	<b>Users:</b> 5000 users with 3-6 digit PINs, 35K event log		

## TRILEGY NETWORKX WIRELESS KEYPADS AND NETPANEL

(continue)



Part No.	Special Features	Finish	List Price
NETPDKPAK/26D	Digital & HID wireless wall mounted keypad kit, includes wall mounted reader, control panel w/door position switch with RX, remote release, battery backup and plug in transformer. <b>Users:</b> 5000 users with 3-6 digit PINs, 35K event log	26D	\$2,054.24
NETWORKXPANEL	NETWORKX wireless control panel only, used with Networkx NETDK and NETPDK readers and approved wiegand input readers		\$971.79
NETHIDNSPAK	HID Narrow Stile Prox point reader, control panel w/door position switch with RX, remote release, and battery backup and plug in transformer		\$1,340.56
NETHIDNS	HID Narrow Stile Prox Point Reader Only		\$268.05

## PDL6300 Series

A double-sided stand-alone door lock provides controlled entry and exit at locations such as airport security areas and police stations. The PDL6300 fully supports Version 2 Gateways and Expanders and features an HID compatible ProxCard® reader, and a real-time clock/calendar that automatically adjusts for Daylight Saving Time and allows for automated programming of events

<b>Door Thickness:</b>	Fits 1 5/8" to 1 7/8".
<b>Backset:</b>	2 3/4" (2 3/8" also available)
<b>Strike:</b>	1 1/8" x 2 3/4" T strike & 1 1/4" x 4 7/8" ASA strike included
<b>Latchbolt:</b>	UL Listed, fire rated 3 hours, 1/2" throw reversible
<b>Handing:</b>	Non-handed
<b>Power:</b>	4 AA batteries (included)
<b>Compliances:</b>	BHMA Certified Grade 1 heavy duty cylindrical lockset. UL listed UL Listed 10C Positive Pressure Specification. FCC Certified . ADA compliant levers
<b>Cylinder:</b>	6 pin solid brass, SC1 keyway, furnished with all key override locks. Schlage, Corbin-Russwin CL, Sargent 480 series, ASSA 65-611 & Lori cylinders can also be used with HW620 tailpiece (supplied)
<b>Interchangeable Core Models:</b>	Standard model accepts 6 & 7 pin cylinders from Arrow, KSP, Medeco Keymark & Kaba Peaks. IC core models prepped for 6 & 7 pin Yale, Medeco, Sargent, Corbin-Russwin & Schlage are also available



Part No.	Special Features	Finish	Prep	List Price
PDL6300/26D	Standard Key override <b>Users:</b> Up to 5,000 3-5 digit codes. Master, Managers, Basic users. 500 scheduled events and 35,000 event audit log	26D	Standard ANSI A115 Series prep, modified by adding additional through-bolt holes	\$3,199.55
PDL6300IC/26D	IC Core <b>Users:</b> Up to 5,000 3-5 digit codes. Master, Managers, Basic users. 500 scheduled events and 35,000 event audit log	26D	Standard ANSI A115 Series prep, modified by adding additional through-bolt holes	\$3,214.92

## PDL1300NW Series

Trilogy® Networx® Narrow Stile Wireless Access Prox/Digital Lock Trim. Add keyless access, automatic lock & free passage schedules to glass doors; plus add remote keyfob support & emergency global lockdown in seconds

- Latch:** Aluminum door retrofit keyless outside trim for Adams Rite® 1850, 1950, 4710, 4070, 4730, 4900 Series and MS1850S and MS1950S Series latch locks
- Door Thickness:** 1 3/4"
- Backset:** 31/32", 1 1/8" and 1 1/2"; Stile thickness 1 3/4"
- Handing:** Non-handed; fully field-reversible
- Power:** Uses standard off-the-shelf AA batteries, choice of advanced Power-Saver modes, for longest battery life, from 3 to 4 years or 100,000 cycles, typ., depending on door use
- Keypad:** All-metal, vandal-resistant 12-button keypad supports 3-6 digit PIN codes, and multilevel user hierarchy (master, manager, supervisor, basic users)
- Prox ID Reader:** (PDL1300NW)CYLINDER: Mortise Cylinder, 1 1/4" supplied.



Part No.	Special Features	Finish	Prep	List Price
PDL1300NW/26D1	Pin/Prox, Networx 3000 Series w/ a lever	26D	Support Adams Rite 4710, 4730, 4900 Series	\$2,067.59
	<b>Users:</b> Supports up to 5000 users - using HID Prox, keyfob, credential &/or - AL-ID ID Cards			
PDL1300NW/10B1	Pin/Prox, Networx 3000 Series w/ a lever	10B	Support Adams Rite 4710, 4730, 4900 Series	\$2,067.59
	<b>Users:</b> Supports up to 5000 users - using HID Prox, keyfob, credential &/or - AL-ID ID Cards			
PDL1300NW/19	Pin/Prox, Networx 3000 Series w/ a lever	19	Support Adams Rite 4070, MS1850S, MS1850S-050, MS1950 MS1950-050	\$2,067.59
	<b>Users:</b> Supports up to 5000 users - using HID Prox, keyfob, credential &/or - AL-ID ID Cards			
PDL1325NW/10B2	Pin/Prox, Networx 3000 series w/ a Turnpiece	10B	Support Adams Rite 4070, MS1850S, MS1850S-050, MS1950 MS1950-050	\$2,067.58
	<b>Users:</b> Supports up to 5000 users - using HID Prox, keyfob, credential &/or - AL-ID ID Cards			
PDL1325NW/26D2	Pin/Prox, Networx 3000 series w/ a Turnpiece	26D	Support Adams Rite 4070, MS1850S, MS1850S-050, MS1950 MS1950-050	\$2,067.58
	<b>Users:</b> Supports up to 5000 users - using HID Prox, keyfob, credential &/or - AL-ID ID Cards			
PDL1300ETNW/26D	Pin/Prox, Networks 3000 Series exit trim w/ a lever	26D		\$2,067.58
	<b>Users:</b> Supports up to 5000 users - using HID Prox, keyfob, credential &/or - AL-ID ID Cards			
PDL1300ETNW/10B	Pin/Prox, Networks 3000 Series exit trim w/ a lever	10B		\$2,067.58
	<b>Users:</b> Supports up to 5000 users - using HID Prox, keyfob, credential &/or - AL-ID ID Cards			
PDL1325ETNW/26D	Pin/Prox, Networks 3000 Series exit trim w/ a Turnpiece	26D		\$2,067.58
	<b>Users:</b> Supports up to 5000 users - using HID Prox, keyfob, credential &/or - AL-ID ID Cards			
PDL1325ETNW/10B	Pin/Prox, Networks 3000 Series exit trim w/ a Turnpiece	10B		\$2,067.58
	<b>Users:</b> Supports up to 5000 users - using HID Prox, keyfob, credential &/or - AL-ID ID Cards			
PDL1350ETNW/10B	Pin/Prox, Networks 3000 Series exit trim w/ a Knob	10B		\$2,067.58
	<b>Users:</b> Supports up to 5000 users - using HID Prox, keyfob, credential &/or - AL-ID ID Cards			
PDL1350ETNW/26D	Pin/Prox, Networks 3000 Series exit trim w/ a Knob	26D		\$2,067.58
	<b>Users:</b> Supports up to 5000 users - using HID Prox, keyfob, credential &/or - AL-ID ID Cards			
TP-1691	ARROW, DCI, VON DUPRIN TAILPC			\$94.32
TP-1692	DOR-O-MATIC 2090			\$94.32
TP-1693	CORBIN ED8200 TAILPIECE			\$94.32
TP-1694	VON DUPRIN 33 TAILPIECE			\$94.32
TP-1698	JACKSON 1095			\$94.32

## PDLN4100 Series

Electronic battery operated digital proximity Networkx lock. Will read 26-37 bit HID card and keyfob formats. Privacy feature will lock out all users for a programmed amount of time. Residency feature-allows exiting without having to lock the door.

<b>Door Thickness:</b>	Fits 1 5/8" to 1 7/8".
<b>Backset:</b>	2 3/4" (2 3/8" also available)
<b>Strike:</b>	1 1/8" x 2 3/4" T strike & 1 1/4" x 4 7/8" ASA strike included
<b>Latchbolt:</b>	UL Listed, fire rated 3 hours, 1/2" throw reversible
<b>Handing:</b>	Non-handed
<b>Power:</b>	4 C alkaline batteries (included)
<b>Keypad:</b>	Weatherproof all metal, 12 button. All functions programmed through keypad. Proximity antenna housing molded of ultra high strength, impact resistant Lexan®
<b>Door prep:</b>	Standard ANSI A115 Series prep, modified by adding additional through-bolt holes
<b>Compliances:</b>	BHMA certified Grade 1 heavy duty cylindrical lockset. UL listed to the 10C Positive Pressure Specification. FCC certified . ADA compliant levers
<b>Cylinder:</b>	6 pin solid brass, SC1 keyway, furnished with all key override locks. Schlage, Corbin-Russwin CL, Sargent 480 series, ASSA 65-611 & Lori cylinders can also be used with HW620 tailpiece (supplied)
<b>Interchangeable Core Models:</b>	Standard model accepts 6 & 7 pin cylinders from Arrow, KSP, Medeco Keymark & Kaba Peaks. IC core models prepped for 6 pin and 7 pin Yale, Medeco, Sargent, Corbin-Russwin & Schlage are also available



Part No.	Special Features	Finish	Prep	List Price
PDLN4100/26D	Standard Key override	26D	Standard ANSI A115 Series prep, modified by adding additional through-bolt holes	\$2,497.84
	<b>Users:</b> Holds up to 2000 codes, Master, Management, Supervisor & basic user. Multiple "one-time" user codes. 500 event schedule, real time clock & 40,000 event audit trail			
PDLN4100IC/26D	IC Core	26D	Standard ANSI A115 Series prep, modified by adding additional through-bolt holes	\$2,523.46
	<b>Users:</b> Holds up to 2000 codes, Master, Management, Supervisor & basic user. Multiple "one-time" user codes. 500 event schedule, real time clock & 40,000 event audit trail			
PDLN4100IC26D-S	Schlage IC Core	26D	Standard ANSI A115 Series prep, modified by adding additional through-bolt holes	\$2,545.17
	<b>Users:</b> Holds up to 2000 codes, Master, Management, Supervisor & basic user. Multiple "one-time" user codes. 500 event schedule, real time clock & 40,000 event audit trail			

## PDLN4500 Series

Electronic battery operated digital proximity networkx lock. Will read 26-37 bit HID card and keyfob formats. Privacy feature will lock out all users for a programmed amount of time. Residency feature-allows exiting without having to lock the door.

- Door Thickness:** Fits 1 3/8" to 1 7/8" (4.46cm). Backset: 2 3/4" standard
- Strike:** 1 1/4" x 4 7/8" strike included
- Handing:** Specify RH or LH when ordering, lock is reversible in the field
- Power:** 4 C alkaline batteries (included)
- Keypad:** Weatherproof all metal, 12 button. All functions programmed through keypad. Proximity antenna housing molded of ultra high strength, impact resistant Lexan®
- Compliances:** Steelcase lockbody meets BHMA specifications for Grade 1 locks. UL listed to the 10C Positive Pressure Specification. FCC Certified. ADA compliant levers
- Functions:** Deadbolt function feature stainless steel deadbolt with 1" (2.55cm) projection, latchbolt with 3/4" (1.91cm) projection and deadlocking latch Deadbolt may be projected from key cylinder from outside door or turn-piece from inside door
- Cylinder:** 1 3/8" (3.5cm) mortise cylinder supplied. Will accept 1 3/8" to 1 1/2" (3.5 - 3.8cm) mortise cylinder. Deadbolt function supplied with cloverleaf cam
- Cams:** Supplied with cloverleaf cam. Cams for other manufacturer's cylinders are available See "Mortise Lock accessories" for part numbers & Manufacturers



Part No.	Special Features	Finish	Prep	List Price
PDLN4500DBL/26D	Straight lever deadbolt function Left hand	26D	Standard ANSI A115 Series prep, modified by adding additional through-bolt holes	\$2,822.25
<b>Users:</b> Holds up to 2000 codes, Master, Management, Supervisor & basic user. Multiple "one-time" user codes. 500 event schedule, real time clock & 40,000 event audit trail				
PDLN4500DBR/26D	Straight lever deadbolt function Left hand	26D	Standard ANSI A115 Series prep, modified by adding additional through-bolt holes	\$2,822.25
<b>Users:</b> Holds up to 2000 codes, Master, Management, Supervisor & basic user. Multiple "one-time" user codes. 500 event schedule, real time clock & 40,000 event audit trail				

## Trilogy Networkx Accessories



Part No.	Description	List Price
AL-IM3-POE	Gateway device used within the Trilogy Networkx™ wireless system. Combines with wireless wall-mounted expanders and plug-in wireless expanders to cover more building space with a single IP address.	\$934.97
AL-IM3-80211	Trilogy Networkx 3rd Generation Gateways interface up to 63 Networkx locks with a PC network. The new 80211 model now features networking via either a hardwire Ethernet connection &/or wirelessly via a bi-directional radio	\$765.73
AL-IME2-EXP	Gateway Expander that Extends coverage range of Gen 2 & 3 Series gateways by approx. 100 feet.	\$406.51
AL-IME2-EXP-POE	Hardwired Gateway Interface Module that interfaces Networkx locks with a PC network with hardwire Power-Over-Ethernet	\$406.53
AL-IME2-PIE	Plug-In Expander extends the coverage area of a Generation 2 Series ALIME2 Gateway to Trilogy Networkx Locks within a PC network	\$406.51
AL-IME-USB	A gateway that will allow for programming of the Networkx locks from a laptop when there is a network disruption	\$487.81

## Accessories

Part No.	Finish	Description	
1752R/26D-F12	26D	Outside IC Lever - Corbin - New Style Lock Body	\$61.22
1752R/26D-F19	26D	Outside Ice Lever - Schlage - New Style Lock Body	\$61.22
1752R/26D-F21	26D	Outside IC Lever - Medeco/Yale - New Style Lock Body (6 Pin)	\$61.22
2101-C		Mortise Straight Cam - Corbin	\$8.27
9HW607-DBLSIDED		Lock body Assembly Double Sided	\$464.11
9HW607ICDBLSDED		Lock body Assembly Double Sided IC Core	\$533.86
9HW607WP-1605		(LOCK BODY FOR TRILOGY CYLINDRICAL LOCKSET (NOT ARCHITECH) - SCHLAGE C - NEW STYLE)	\$539.42
9HW607WPIC-1605		LOCK BODY FOR TRILOGY CYLINDRICAL LOCKSET (NOT ARCHITECH) - SFIC - NEW STYLE	\$592.37
9HW607WPICY1605		LOCK BODY FOR TRILOGY CYLINDRICAL LOCKSET (NOT ARCHITECH) - LFIC - CORBIN, YALE, SCHLAGE - NEW STYLE	\$592.37
9TAILPCICRASSY		BEST,ARROW,FALCON,SARGENT IC TAIL PIECE BAG	\$26.47
AL-DTMIll		Data Transfer Module	\$741.29
AL-NSG		A portable battery powered Network Gateway simulation device that generates continuous Gateway radio signals to a Network Signal Meter	\$409.76
AL-NSM		A Site survey toll Performs a site survey test of the premises to find optimum location of Network gateways & locks. Also helps to determine the number of gateways required to cover the signal area of the Network locks you plan to install.	\$505.36
AL-PRE2		Prox Card Enroller - HID and iClass	\$944.90
ALHID1391		MicroProx Tag 10 per box	\$154.34
ALID1326		Proximity Access Cards 100 Per Box	\$474.37
ALID1326C/25		PROXCARD2 25 PACK	\$118.59
ALPCI2-U		USB computer interface cable includes DL-Windows software	\$392.16
CICCP5I-4HN36		PRINTABLE PROX NAPCO 36 BIT MUST ORDER QTY 100	\$763.90
ET-AL/10B	10B	Panic Exit Lock Cylinder Kit for AL	\$94.32
ET-AL/26D	26D	Panic Exit Lock Cylinder Kit for AL	\$94.32
ET-AR/10B	10B	Panic Exit Lock Cylinder Kit for Arrow	\$94.32
ET-AR/26D	26D	Panic Exit Lock Cylinder Kit for Arrow	\$94.32
ET-ARIC/10B	10B	Panic Exit Lock Cylinder Kit for Arrow	\$130.72
ET-ARIC/26D	26D	Panic Exit Lock Cylinder Kit for Arrow	\$130.72
ET-AS/10B	10B	Panic Exit Lock Cylinder Kit for ASSA	\$94.32
ET-AS/26D	26D	Panic Exit Lock Cylinder Kit for ASSA	\$94.32
ET-BIC/10B	10B	Panic Exit Lock Cylinder Kit for Best	\$130.72
ET-BIC/26D	26D	Panic Exit Lock Cylinder Kit for Best	\$130.72
ET-C/10B	10B	Panic Exit Lock Cylinder Kit for Corbin	\$94.32
ET-C/26D	26D	Panic Exit Lock Cylinder Kit for Corbin	\$94.32
ET-CIC/10B	10B	Panic Exit Lock Cylinder Kit for Corbin	\$130.72
ET-CIC/26D	26D	Panic Exit Lock Cylinder Kit for Corbin	\$130.72
ET-M/10B	10B	Panic Exit Lock Cylinder Kit for Medeco	\$94.32
ET-M/26D	26D	Panic Exit Lock Cylinder Kit for Medeco	\$94.32
ET-MIC/10B	10B	Panic Exit Lock Cylinder Kit for Medeco	\$130.72

**Accessories** (continue)

Part No.	Finish	Description	
ET-MIC/26D	26D	Panic Exit Lock Cylinder Kit for Medeco	\$130.72
ET-R/10B	10B	Panic Exit Lock Cylinder Kit for Sargent	\$94.32
ET-R/26D	26D	Panic Exit Lock Cylinder Kit for Sargent	\$94.32
ET-RIC/10B	10B	Panic Exit Lock Cylinder Kit for Sargent	\$130.72
ET-RIC/26D	26D	Panic Exit Lock Cylinder Kit for Sargent	\$130.72
ET-S/10B	10B	Panic Exit Lock Cylinder Kit for Schlage	\$94.32
ET-S/26D	26D	Panic Exit Lock Cylinder Kit for Schlage	\$94.32
ET-SIC/10B	10B	Panic Exit Lock Cylinder Kit for Schlage	\$130.72
ET-SIC/26D	26D	Panic Exit Lock Cylinder Kit for Schlage	\$130.72
ET-Y/10B	10B	Panic Exit Lock Cylinder Kit for Yale	\$94.32
ET-Y/26D	26D	Panic Exit Lock Cylinder Kit for Yale	\$94.32
ET-YIC/10B	10B	Panic Exit Lock Cylinder Kit for Yale	\$130.72
ET-YIC/26D	26D	Panic Exit Lock Cylinder Kit for Yale	\$130.72
HW1343B		Best Ic Mortise Cam	\$18.20
HW1344		Corbin-Russwin standard cam	\$8.27
HW1345		Corbin IC Mortise Cam	\$18.20
HW1346		MARKS Mortise Cam	\$8.27
HW1348		Sargent Mortise cam	\$8.27
HW1349		Schlage Mortise Cam	\$8.27
HW1351		Yale IC Mortise Cam	\$18.21
HW1883C-10B3	10B	Regal Exit Trim Lever Handle	\$61.41
HW1883C-26D	26D	Regal Exit Trim Lever Handle	\$61.41
HW1885B-10B3	10B	Straight Exit Trim lever Handle	\$61.41
HW1885B-26D	26D	Straight Exit Trim lever Handle	\$61.41
HW2037	D70	Severe weather keypad guard	\$33.51
HW470-10B	10B	Strike	\$24.82
HW470-US3	US3	Strike	\$24.82
HW577-32D	32D	Strike	\$26.47
HW577-US10B	10B	Strike	\$26.47
HW577-US3	32D	Strike	\$26.47
HW580		Tail Piece ASSEMBLY- Schlage	\$18.20
HW592G-10B	10B	Battery cover	\$34.75
HW592G-26D	26D	Battery cover	\$34.75
HW596F-10B	10B	Cylinder Assembly w/ 2 Keys Cylinder	\$43.02
HW596F-26D	26D	Cylinder Assembly w/ 2 Keys	\$43.02
HW596F-US3	US3	Cylinder Assembly w/ 2 Keys	\$43.02
HW597E		K.I.L. TAILPIECE	\$18.20
HW598E		REMOVABLE CORE(I.C.) TAILPIECE	\$18.20
HW614E-10B	10B	OUTSIDE LEVER HANDLE 10B FINISH - USED WITH OLD STYLE LOCK BODY	\$61.22
HW614E-26D	26D	OUTSIDE LEVER HANDLE 26D FINISH - USED WITH OLD STYLE LOCK BODY	\$61.22
HW615F-10B	10B	INSIDE LEVER HANDLE 10B FINISH - USED WITH NEW AND OLD STYLE LOCK BODY	\$61.22



## Accessories (continue)

HW615F-26D	26D	INSIDE LEVER HANDLE 26D FINISH - USED WITH NEW AND OLD STYLE LOCK BODY	\$61.22
HW616G-10B	10B	UL-OUTSIDE LEVER SFIC USED WITH NEW AND OLD STYLE LOCK BODY	\$61.22
HW616G-26D	26D	UL-OUTSIDE LEVER SFIC USED WITH NEW AND OLD STYLE LOCK BODY	\$61.22
HW620D		TAILPIECE - LORI CYL.	\$18.20
HW751D-26D	26D	OUTSIDE IC LEVER - SARGENT - NEW AND OLD STYLE LOCK BODY	\$61.22
HW865CR-26D		STRIKE FACE PLATE KIT CR 26D	\$31.23
HW867DB-26D		STRIKE/FACE PLATE KIT DB 26D	\$31.23
HW870CRL		MORTISE LOCK BODY KIT LH	\$282.95
HW875CRR		MORTISE LOCK BODY KIT RH	\$282.95
HW903DBL		MORTISE LOCK BODY KIT,DB,LH	\$282.95
HW904DBR		MORTISE LOCK BODY KIT,DB,RH	\$282.95
HW956-A		MORTISE STRAIGHT CAM-ARROW	\$8.27
HW956-L		MORTISE STRAIGHT CAM-ALOCK	\$8.27
HW956-M		MORTISE STRAIGHT CAM-MARKS	\$8.27
HW957-A		MORTISE CLOVERLEAF CAM-ARROW	\$8.27
HW957-C		MORTISE CLOVERLEAF CAM-CORBIN	\$8.27
KH36-10		Napco Branded Keyfob, HID 125-kHz Proximity, 36-bit, 10pk	\$48.90
MX942		BANANA PLUG FITS MX941	\$33.09
P5849-10B	10B	LATCH BOLT, SNGL PT	\$43.02
P5849-26D	26D	LATCH BOLT, SNGL PT	\$43.02
P5849-US3		LATCH BOLT, SNGL PT	\$43.02
RR-1BUTTON		REMOTE RELEASE TRILOGY NETWORK	\$185.51
RR-4BKEYFOB		4 BUTTON KEYFOB TRANSCEIVER	\$207.69
RR-EXITTRIMKIT		TRANSCEIVER EXIT TRIM	\$487.96
RR-MORTISEKIT		TRANSCEIVER MORTISE LOCK	\$487.96
RR-RECEIVER		TRANSCEIVER	\$258.09
RR-TRILOGYKIT		REMOTE RELEASE KT FOR CYL LCKS	\$445.62
S5980-1	26D	LATCH ASSEMBLY, 23/8 BACKSET	\$43.02
S5980-2		LATCH ASSEMBLY, 23/8 BACKSET	\$43.02
S6045		LOCK BODY FOR TRILOGY CYLINDRICAL LOCKSET (NOT ARCHITECH) - SCHLAGE C - OLD STYLE	\$539.42
S6045-C/R		WP CORBIN/SARGENT IC LOCK BODY - OLD STYLE	\$592.37
S6045-S		WP SCHLAGE IC LOCK BODY - OLD STYLE	\$592.37
S6045-Y/M		WP YALE/MEDICO IC LOCK BODY - OLD STYLE	\$592.37
S6046		LOCK BODY ASSEMBLY, DL2700/3000ICWP - OLD STYLE	\$539.42
S6054-10B	10B	Complete outside housing for DL2700WP	\$622.15
S6054-26D	26D	Complete outside housing for DL2700WP	\$622.15
S6061		DL2700WP BATTERY PACK COMPLETE	\$77.77
S6065		BATTERY PACK FOR MORTISE LOCK	\$62.88
S6070-C		CORBIN TAILPIECE BAG ASSEMBLY	\$26.47
S6070-K.I.L.		KABA ILCO LORI TAIL PIECE	\$26.47
S6070-M		MEDECO TAILPIECE BAG ASSEMBLY	\$26.47
S6070-S		SCHLAGE TAILPIECE BAG ASSEMBLY	\$26.47

## Accessories (continue)

Part No.	Finish	Description	
S6070-Y		YALE TAILPIECE BAG ASSEMBLY	\$26.47
S6072		SET OF SPACERS 1-3/8" DOOR	\$115.83
S6122-10B	10B	Complete outside housing for PDL3000	\$1,798.62
S6122-26D	26D	Complete outside housing for PDL3000	\$1,798.62
S6146		SHAFT SPINDLE FOR 2" TO 2 3/4" (Exit Trim)	\$185.32
S6147		SHAFT SPINDLE FOR 3" TO 4" (Exit Trim)	\$185.32
S6148		LEVER RETURN SPRING	\$8.27
S6161		INSIDE BATTERY KIT	\$100.93
S6163-26D	26D	OUTSIDE HOUSING-DL4100	\$867.04
S6164-26D	26D	OUTSIDE HOUSING-PDL4100	\$1,477.61
S6169-10B	10B	BEST CYLINDER HOUSING WITH CAM	\$69.50
S6169-26D	26D	BEST CYLINDER HOUSING WITH CAM	\$69.50
S6170		NARROW STYLE BATTERY PACK	\$62.88
S6172		DOUBLE SIDED LOCK BATTERY	\$49.64
S6174		ET BATTERY CASE	\$79.42
S6175		ET/MORTISE LEVER RETURN SPRING	\$4.96
S6187		RADIO BD & BATT HSG NETWORK ET	\$315.86
S6188		HW1824 RIGHT & LEFT Assembly	\$41.11
S6190		EXIT TRIM SERVICE KIT	\$249.85
S6191-10B		EXIT TRIM LEVER REPLACEMENT KIT	\$100.93
S6191-26D		EXIT TRIM LEVER REPLACEMENT KIT	\$100.93
S6193-10B		MORTISE REGAL LEVER REPLACMNT KIT	\$129.06
S6193-26D		MORTISE REGAL LEVER REPLACMNT KIT	\$129.06
S6195		SHAFT SPINDLE FOR 4.5" TO 5" (Exit Trim)	\$185.32
S6196		Best IC housing with cam attached 26D, 10B	\$76.83
S6197		EXTENSION LINK 3-3/4" BACKSET	\$48.04
S6198		EXTENSION LINK 5" BACKSET	\$48.04
S6206-26D	26D	OUTSIDE HOUSING-DL3200	\$1,163.43
SC544 (must order 4)		#8-32 SCR,PH,MS,ADJUST. LENGTH	\$34.75
TP-1691		ARROW, DCI, VON DUPRIN TAILPC	\$94.32
TP-1692		DOR-O-MATIC 2090	\$94.32
TP-1693		CORBIN ED8200 TAILPIECE	\$94.32
TP-1694		VON DUPRIN 33 TAILPIECE	\$94.32
TP-1698		JACKSON 1095	\$94.32
WA160D		TAILPIECE WASHER	\$4.96

## Trilogy Accessories

PE1		ROUND RED EXIT BUTTON NON-ILLUMINATE STANDARD SWITCH PLATE	\$212.76
PE2		SQUARE GREEN ILLUMINATED EXIT BUTTON STANDARD SWITCH PLATE	\$212.76
PE2S		SQUARE GREEN ILLUMINATED EXIT BUTTON NARROW SWITCH PLATE	\$212.76

## Architech Series Network Locks

Ideal access control solution; elegantly blending advanced wireless access control convenience within any decor, in attractive, infinitely customizable designer locking form, in choice of trims and finishes. **Bluetooth optional purchase.**

**ANSI / BHMA Grade 1 Certified, UL Listed 3 Hours Includes standard lever rose hardware design**

**Compatible with all 300+ optional architectural trim / lever or knob designs Stainless steel latch, 2-3/4" backset**

**Auto-Reverse lock body tested to 6 million cycles Lock Body - Self cleaning long life motor**

**Door monitoring/electronic deadbolt monitor Key override standard or high-Security**

**Optional integrated door position indicator switch**



Part No.	Special Features	Finish	List Price
N90S1195F26D	Cylindrical, Surface Mount , Oval Prox, American Lever, storeroom Function <b>Users:</b> 5000 Users, 500 Scheduled Events & 40,000 Event Audit	26D	\$1,502.46
N90S2195F26D	Cylindrical, Surface Mount, Square Prox, American Lever, storeroom Function <b>Users:</b> 5000 Users, 500 Scheduled Events & 40,000 Event Audit	26D	\$1,502.46
N95S1RW92LFD32D	Mortise, Surface Mount, Square Prox, Left Handed, Plain Rose, American Lever, Apartment Function <b>Users:</b> 5000 Users, 500 Scheduled Events & 40,000 Event Audit	32D	\$1,878.07
N95S1RW92RFD32D	Mortise, Surface Mount, Oval Prox, Right Handed, Plain Rose, American Lever, Apartment Function <b>Users:</b> 5000 Users, 500 Scheduled Events & 40,000 Event Audit	32D	\$1,878.07
N95S2RX86LFD32D	Mortise, Surface Mount, Square Prox, Square Rose, Crescent Lever, Left Handed, Apartment Function <b>Users:</b> 5000 Users, 500 Scheduled Events & 40,000 Event Audit	32D	\$1,878.07
N95S2RX86RFD32D	Mortise, Surface Mount, Square Prox, Square Rose, Crescent Lever, Right Handed, Apartment Function <b>Users:</b> 5000 Users, 500 Scheduled Events & 40,000 Event Audit	32D	\$1,878.07
N90L1195F26D	Cylindrical, Lockdown, Oval Prox, American lever, storeroom function <b>Users:</b> 5000 Users, 500 Scheduled Events & 40,000 Event Audit	26D	\$1,587.84
N90L1295F26D	Cylindrical, lockdown, Oval Prox, Crescent Lever, storeroom Function <b>Users:</b> 5000 Users, 500 Scheduled Events & 40,000 Event Audit	26D	\$1,587.84
N90L1195F10BF19	Cylindrical, lockdown, Oval Prox, American Lever, storeroom Function, Schlage 6 Pin IC Core <b>Users:</b> 5000 Users, 500 Scheduled Events & 40,000 Event Audit	10B	\$1,640.45
N90S1195F10B	Cylindrical, surface mount, Oval Prox, American Lever, storeroom Function <b>Users:</b> 5000 Users, 500 Scheduled Events & 40,000 Event Audit	10B	\$1,502.46
N90S1195F10BF19	Cylindrical, surface mount, Oval Prox, American Lever, Marks Function, Schlage 6 Pin IC Core <b>Users:</b> 5000 Users, 500 Scheduled Events & 40,000 Event Audit	10B	\$1,555.26
N90S1195F26D-D2	Cylindrical, surface mount, oval prox, American lever, storeroom function, 2 1/4" door thickness <b>Users:</b> 5000 Users, 500 Scheduled Events & 40,000 Event Audit	26D	\$1,766.48

## Architech Series Network Locks (continue)



Part No.	Special Features	Finish	List Price
N90S1195F26DF19	Cylindrical, surface mount, oval prox, American lever, storeroom function, Schlage 6 Pin IC Core <b>Users:</b> 5000 Users, 500 Scheduled Events & 40,000 Event Audit	26D	\$1,555.26
N90S1195RF26D	Cylindrical, surface mount, oval prox, American lever, storeroom function, right handed <b>Users:</b> 5000 Users, 500 Scheduled Events & 40,000 Event Audit	26D	\$1,502.46
N90S2195F3	Cylindrical, surface mount, square prox, American lever, storeroom function <b>Users:</b> 5000 Users, 500 Scheduled Events & 40,000 Event Audit	3	\$1,502.46
N90S2195RF26D	Cylindrical, surface mount, square prox, American lever, storeroom function <b>Users:</b> 5000 Users, 500 Scheduled Events & 40,000 Event Audit	26D	\$1,502.46
N90SA195RF26D	Cylindrical, surface mount, iClass oval prox, American lever, storeroom function, right handed <b>Users:</b> 5000 Users, 500 Scheduled Events & 40,000 Event Audit	26D	\$1,678.47
N90SB195RF26D	Cylindrical, surface mount, iClass square prox, American lever, storeroom function, right handed <b>Users:</b> 5000 Users, 500 Scheduled Events & 40,000 Event Audit	26D	\$1,678.47
N90T1195F26D	Cylindrical, Surface Mount w/ bluetooth , Oval Prox, American Lever, storeroom Function <b>Users:</b> 5000 Users, 500 Scheduled Events & 40,000 Event Audit	26D	\$1,678.47
N90T2195F26D	Cylindrical, Surface Mount w/ bluetooth , square Prox, American Lever, storeroom Function <b>Users:</b> 5000 Users, 500 Scheduled Events & 40,000 Event Audit	26D	\$1,678.47
N9511RW86LFD32D	Mortise, electronic insert, oval Prox, plain Rose, Crescent Lever, left Handed, Apartment Function <b>Users:</b> 5000 Users, 500 Scheduled Events & 40,000 Event Audit	32D	\$1,878.07
N9511RW86RFD32D	Mortise, electronic insert, oval Prox, plain Rose, Crescent Lever, right Handed <b>Users:</b> 5000 Users, 500 Scheduled Events & 40,000 Event Audit	32D	\$1,878.07
N95J1RW86LAD32D	Mortise, electronic insert w/ bluetooth, oval Prox, plain Rose, Crescent Lever, left Handed, automatic deadbolt <b>Users:</b> 5000 Users, 500 Scheduled Events & 40,000 Event Audit	32D	\$2,054.08
N95S1RW86LFD26D	Mortise, surface mount, oval Prox, plain Rose, Crescent Lever, left Handed, Apartment Function <b>Users:</b> 5000 Users, 500 Scheduled Events & 40,000 Event Audit	32D	\$1,878.07
N95S1RW86LFD32D	Mortise, surface mount, oval Prox, plain Rose, Crescent Lever, left Handed, Apartment Function <b>Users:</b> 5000 Users, 500 Scheduled Events & 40,000 Event Audit	32D	\$1,878.07
N95S1RW86RFD32D	Mortise, surface mount, oval Prox, plain Rose, Crescent Lever, right Handed, Apartment Function <b>Users:</b> 5000 Users, 500 Scheduled Events & 40,000 Event Audit	32D	\$1,878.07
N95S1RW92LEW26D	Mortise, surface mount, oval Prox, plain Rose, American Lever, left Handed, storeroom Function <b>Users:</b> 5000 Users, 500 Scheduled Events & 40,000 Event Audit	26D	\$1,878.07
N95S1RW92LFD26D	Mortise, surface mount, oval Prox, plain Rose, American Lever, left Handed, apartment Function <b>Users:</b> 5000 Users, 500 Scheduled Events & 40,000 Event Audit	26D	\$1,878.07

## Architech Series Network Locks (continue)



N95S1RW92LFD32D	Mortise, surface mount, oval Prox, plain Rose, American Lever, left Handed, apartment Function	32D	\$1,878.07
<b>Users:</b> 5000 Users, 500 Scheduled Events & 40,000 Event Audit			
N95S1RW92RFD26D	Mortise, surface mount, oval Prox, plain Rose, American Lever, right Handed, apartment Function	26D	\$1,878.07
<b>Users:</b> 5000 Users, 500 Scheduled Events & 40,000 Event Audit			
N95S1RX92RFD32D	Mortise, surface mount, oval Prox, square Rose, American Lever, right Handed, apartment Function	32D	\$1,878.07
<b>Users:</b> 5000 Users, 500 Scheduled Events & 40,000 Event Audit			
N95S2RW86LEW26D	Mortise, surface mount, square Prox, plain Rose, crescent Lever, left Handed, storeroom Function	26D	\$1,878.07
<b>Users:</b> 5000 Users, 500 Scheduled Events & 40,000 Event Audit			
N95S2RW86REW26D	Mortise, surface mount, square Prox, plain Rose, crescent Lever, right Handed, storeroom Function	26D	\$1,878.07
<b>Users:</b> 5000 Users, 500 Scheduled Events & 40,000 Event Audit			
N95S2RW92LAD32D	Mortise, surface mount, square Prox, plain Rose, American Lever, left Handed, automatic deadbolt	32D	\$1,878.07
<b>Users:</b> 5000 Users, 500 Scheduled Events & 40,000 Event Audit			
N95S2RW92RAD32D	Mortise, surface mount, square Prox, plain Rose, American Lever, right Handed, automatic deadbolt	32D	\$1,878.07
<b>Users:</b> 5000 Users, 500 Scheduled Events & 40,000 Event Audit			
N95S2RX92FD32D	Mortise, surface mount, square Prox, square Rose, American Lever, apartment function	32D	\$1,878.07
<b>Users:</b> 5000 Users, 500 Scheduled Events & 40,000 Event Audit			
N95S2RX92LFD32D	Mortise, surface mount, square Prox, square Rose, American Lever, left handed, apartment function	32D	\$1,878.07
<b>Users:</b> 5000 Users, 500 Scheduled Events & 40,000 Event Audit			
N95S2RX92RFD32D	Mortise, surface mount, square Prox, square Rose, American Lever, right handed, apartment function	32D	\$1,878.07
<b>Users:</b> 5000 Users, 500 Scheduled Events & 40,000 Event Audit			
N95S7RW92LAD32D	Mortise, surface mount, keypad, plain Rose, American Lever, left handed, automatic deadbolt	32D	\$2,021.78
<b>Users:</b> 5000 Users, 500 Scheduled Events & 40,000 Event Audit			
N95T1RW83LEW26D	Mortise, surface mount w/ bluetooth, oval prox, plain Rose, dayton Lever, left handed, storeroom function	26D	\$2,054.08
<b>Users:</b> 5000 Users, 500 Scheduled Events & 40,000 Event Audit			
N95T1RW83REW26D	Mortise, surface mount w/ bluetooth, oval prox, plain Rose, dayton Lever, right handed, storeroom function	26D	\$2,054.08
<b>Users:</b> 5000 Users, 500 Scheduled Events & 40,000 Event Audit			
N95T2RX92LAD32D	Mortise, surface mount w/ bluetooth, square prox, square Rose, American Lever, left handed, automatic deadbolt	32D	\$2,054.08
<b>Users:</b> 5000 Users, 500 Scheduled Events & 40,000 Event Audit			
N95T2RX92RAD32D	Mortise, surface mount w/ bluetooth, square prox, square Rose, American Lever, right handed, automatic deadbolt	32D	\$2,054.08
<b>Users:</b> 5000 Users, 500 Scheduled Events & 40,000 Event Audit			
AL-APB	Architech Power booster		\$1,757.48

## ArchiTech Series Network Locks

### Electronics

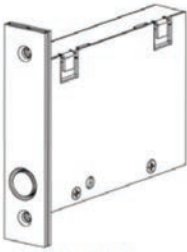

**MORTISED NETWORK CONTROL MODULE**

**I - Inserted**

**J - Inserted BLE**

**S - Surface**

**T - Inserted BLE**

**L - Lockdown**

**M - Lockdown BLE**

**P - Privacy**

**Q - Privacy BLE**

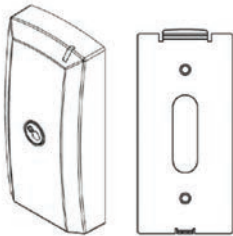

**"SURFACE-MOUNTED" NETWORK CONTROL UNIT AND ITS MOUNTING PLATE**

### Wired Readers



**1 - Prox Oval**

**2 - Prox Square**



**A - iClass Oval**

**B - iClass Square**

**C - Concealed**  
(Wood or Composite doors only)



**M - Multi-Class iClass/Prox**



**7 - Keypad Prox**

### Wireless Readers

For R90 and R95 Only



**F - Oval Wireless Prox**



**H - Horizontal KP/Prox**



**V - Vertical KP/Prox**



**W - Square Glass KP/Prox**



*Concealed Electronics*



*Mortise-In Electronics & Batteries*



*Cylindrical; Surface Mounted Electronics*



*Mortise; Surface Mounted Electronics*



*Keypad*

## ArchiTech Series Cylindrical Locks

Models	Base Price	Electronics	Add On
N90	1502.46	I	-
R90	1502.46	J	74.93
		S	-
		T	74.93
		L	74.93
		M	149.86
		P	74.93
		Q	149.86
Finish	Add On	Option	Add On
3	-	F7	15.00
4	42.65	F8	15.00
10	42.65	F12	22.00
10B	42.65	F13	22.00
19	42.65	F14	15.00
26	42.65	F15	15.00
26D	-	F19	15.00
		F20	15.00
		F21	15.00
		G3	-10.00
Reader	Add On	Trim Type	Add On
1	-	195	-
2	-	295	-
7	74.93	495	-
A	74.93		
B	74.93		
C	-		
D	149.86		
E	149.86		
F	149.86		
H	149.86		
V	149.86		
W	238.00		

### How to order ArchiTech Cylindrical Models

Base distribution cylindrical model P/N scheme

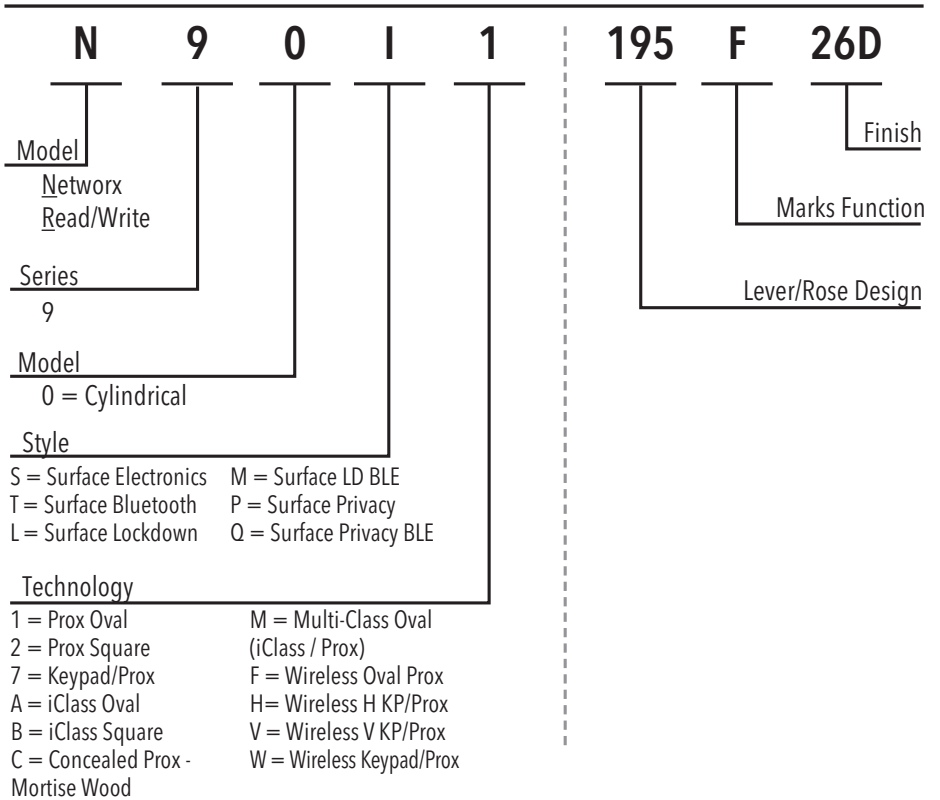

### Choice of Levers - Cylindrical Models



195 - American Lever



295 - Crescent Lever



495 - Titan Lever

No up-charge for Marks (Best) SFIC. Specify "RF" for SFIC

\*Note: Please consult factory for availability of other finishes. Round rose place only available with cylindrical version (3.5" diameter).

IC core models: tail piece included, core not included.

## Architech Series Mortise Locks

Models	Base Price	Electronics	Add On	Reader	Add On	Trim	Add On	Lever	Add On	Finish	Add On	Option	Add On
N95	1878.07	I	-	1	-	RQ	-	002	-	3	-	G1	-
R95	1878.07	J	81.30	2	-	RR	-	031	-	4	49.27	G3	-10.00
		S	-	7	81.30	RS	-	037A	-	5	-	G6	-
		T	81.30	A	81.30	RW	-	47C	-	10	49.27	G7	51.00
		L	81.30	B	81.30	RX	20.26	55	-	10B	49.27	G8	-
		M	162.60	C	-	RK	46.86	57	-	11	49.27		
		P	81.30	D	162.60	RL	66.49	72	-	14	49.27		
		Q	162.60	E	162.60	LA	169.51	77	-	15	49.27		
				F	162.60	CR	119.59	78	-	19	49.27		
				H	162.60	DR	169.51	82	-	20A	49.27		
				V	162.60			83	-	26	49.27		
				W	238.00			86	-	26D	-		
								92	-	32	-		
								96	-	32D	-		
								BH29	1254.77				

KNOBBS	Round Knob 10	Ball Knob 20	Commerce Lever 037A	Metropolitan Lever 002	ROSES	RR: 2-9/16" dia.
						RW: 2-9/16" dia.
LEVERS	Lucida Lever 47C	Copa Lever 031	Brompton Lever 55	Monaco Lever 57 Specify handing	ROSES	RQ: 2-1/4" dia.
	Towne Lever 72	Maxwell Lever 77	Omni Lever 78	Plaza Lever 82		RS: 2-1/4" dia.
	Dayton Lever 83 Specify handing	Crescent Lever 86	American Lever 92	Titan Lever 96		RX: 2-1/2"sq, RK: 2-1/2"sq, RL: 1-1/2"sq.
						Wrought
						Forged

### Functions for Mortise Locks

CODE	FUNCTION	DESCRIPTION
FD	APARTMENT	Latch by lever either side except when outside locked by stop-button or projected deadbolt. Latch deadlocked by auxiliary latch or deadbolt & latch by key outside. Deadbolt by turn piece inside. Inside knob/lever retracts latch & deadbolt simultaneously, leaving outside locked.
E	STOREROOM	Latch by lever inside, key outside. Outside lever always rigid. Auxiliary latch deadlocks latch. Inside always open.
AD	AUTOMATIC DEADBOLT	Latch deadlocked by deadbolt automatically when door closes. Deadbolt & latch by key or residential outside. Inside lever retracts latch & deadbolt simultaneously, leaving outside locked.

## How to Order ArchiTech Mortise Models

Base distribution cylindrical model P/N scheme

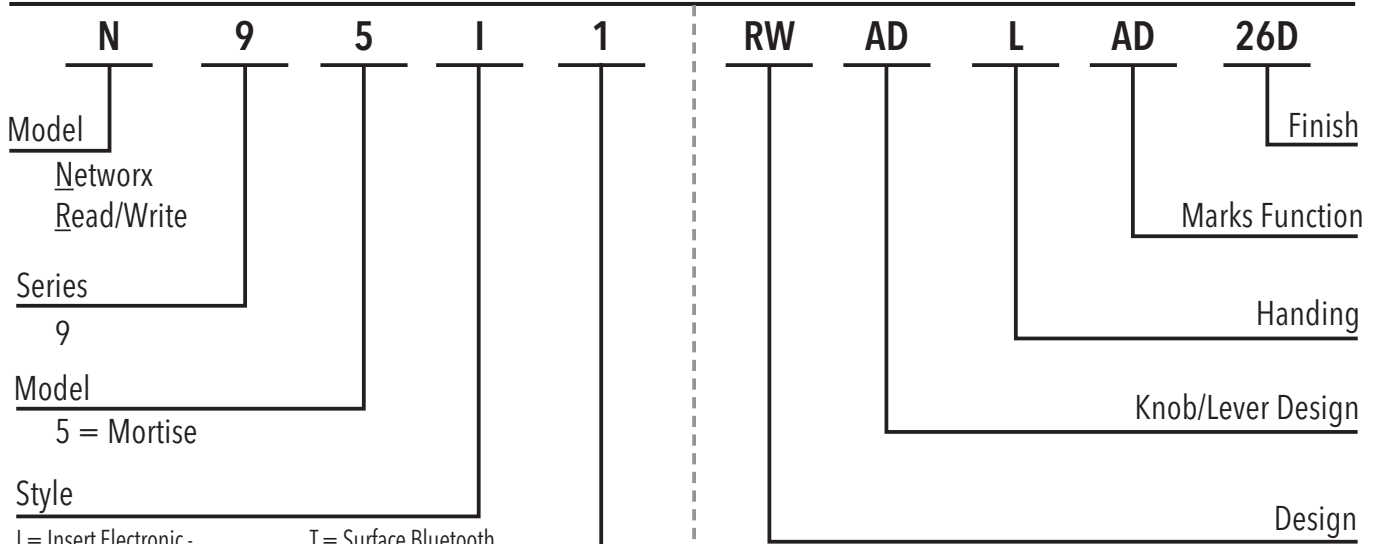

LOCK TYPE	READER TYPE												
	1	2	7	A	B	C	D	E	F	H	V	W	
N90I	s/o	s/o	s/o	s/o	s/o	s/o	s/o	n/a	n/a	n/a	n/a	N/A	
N90J	s/o	s/o	s/o	s/o	s/o	s/o	s/o	n/a	n/a	n/a	n/a	N/A	
N90S	✓	✓	✓	✓	✓	n/a	s/o	n/a	n/a	n/a	n/a	N/A	
N90T	✓	✓	✓	✓	✓	n/a	s/o	n/a	n/a	n/a	n/a	N/A	
N90L	✓	✓	s/o	✓	✓	n/a	s/o	n/a	n/a	n/a	n/a	N/A	
N90M	s/o	s/o	s/o	s/o	s/o	n/a	s/o	n/a	n/a	n/a	n/a	N/A	
N90P	n/a	n/a	✓	n/a	n/a	n/a	n/a	n/a	n/a	n/a	n/a	N/A	
N90Q	n/a	n/a	s/o	n/a	n/a	n/a	n/a	n/a	n/a	n/a	n/a	N/A	
N95I	✓	✓	✓	✓	✓	✓	s/o	n/a	n/a	n/a	n/a	N/A	
N95J	✓	✓	✓	✓	✓	✓	s/o	n/a	n/a	n/a	n/a	N/A	
N95S	✓	✓	✓	✓	✓	n/a	s/o	n/a	n/a	n/a	n/a	N/A	
N95T	✓	✓	✓	✓	✓	n/a	s/o	n/a	n/a	n/a	n/a	N/A	
N95L	✓	✓	s/o	✓	✓	n/a	s/o	n/a	n/a	n/a	n/a	N/A	
N95M	s/o	s/o	s/o	s/o	s/o	n/a	s/o	n/a	n/a	n/a	n/a	N/A	
N95P	n/a	n/a	s/o	n/a	n/a	n/a	n/a	n/a	n/a	n/a	n/a	N/A	
N95Q	n/a	n/a	s/o	n/a	n/a	n/a	n/a	n/a	n/a	n/a	n/a	N/A	
R90I	s/o	s/o	s/o	s/o	s/o	s/o	s/o	s/o	s/o	s/o	s/o	S/O	
R90J	✓	✓	s/o	s/o	s/o	s/o	s/o	s/o	s/o	s/o	s/o	S/O	
R90S	✓	✓	s/o	s/o	s/o	n/a	s/o	s/o	s/o	s/o	s/o	S/O	
R90T	✓	✓	s/o	s/o	s/o	n/a	s/o	s/o	s/o	s/o	s/o	S/O	
R90L	✓	✓	s/o	s/o	s/o	n/a	s/o	s/o	s/o	s/o	s/o	S/O	
R90M	s/o	s/o	s/o	s/o	s/o	n/a	s/o	s/o	s/o	s/o	s/o	S/O	
R90P	n/a	n/a	✓	n/a	n/a	n/a	n/a	s/o	s/o	s/o	s/o	S/O	
R90Q	n/a	n/a	s/o	n/a	n/a	n/a	n/a	s/o	s/o	s/o	s/o	S/O	
R95I	✓	✓	✓	✓	✓	✓	s/o	s/o	s/o	s/o	ü	✓	
R95J	✓	✓	✓	✓	✓	✓	s/o	s/o	s/o	s/o	ü	✓	
R95S	✓	✓	✓	✓	✓	n/a	s/o	s/o	s/o	s/o	ü	✓	
R95T	✓	✓	✓	✓	✓	n/a	s/o	s/o	s/o	s/o	ü	✓	
R95L	✓	✓	s/o	✓	✓	n/a	s/o	s/o	s/o	s/o	s/o	S/O	
R95M	s/o	s/o	s/o	s/o	s/o	n/a	s/o	s/o	s/o	s/o	s/o	S/O	
R95P	n/a	n/a	s/o	n/a	n/a	n/a	n/a	s/o	s/o	s/o	s/o	S/O	
R95Q	n/a	n/a	s/o	n/a	n/a	n/a	n/a	s/o	s/o	s/o	s/o	S/O	

## ArchiTech Series Network Locks Parts & Accessories

PRODUCT	DESCRIPTION	PRICE
AL-IME2EXP	Wireless Expander designed to expand the coverage area of version 2 gateways. AC power required. Up to 7 expanders per version 2 gateway	426.83
AL-IME2-PIE	Plug-in wireless expander, as above - Plugs into standard AC outlet	426.83
AL-IME-USB	USB Gateway (not for lockdown)	903.88
AL-PRE2	Prox card enroller - HID and iClass	1057.70
AL-NSM	Network Signal Meter	505.37
AL-NSG	Network Signal Generator	409.76
AL-PB	ArchiTech Power Booster	2212.71
ALHID1326	Proximity Access Cards 100 Per Box	591.41
ALHID1391	MicroProx Tag 10 per box	147.00
AL-IM3-80211	3rd Generation Hardware/Wireless Gateway	810.98
AL-IM3-POE	3rd Generation Hardware/Wireless POE Gateway	981.72
KH-36-10	Napco Branded Keyfob 10 pack	48.90
AL-4BKEYFOB	4 Button Remote Fob	190.85
AL-IDRW	Card Write-ReWriter	1057.70

### Use the iLock App to unlock your Network ArchiTech® Bluetooth® Series Door Lock in seconds!



Introducing iLock, the easy smartphone mobile solution for unlocking your Trilogy® ArchiTech Bluetooth Series Designer Access Control Locks from any smart device without the need to carry cumbersome ID cards or keys. Password protected access is secure through the use of Bluetooth LE® and proprietary encryption. Additionally, an optional feature can be utilized, requiring a password for each unlock request.

The Key is Your Smartphone & More Secure Technology

Any Smart Device can be the Access Key: Much more than an ID card displayed on your smartphone, for your security, ArchiTech & its iLock App are wirelessly linked together, each supplying its portion of stored encrypted data to provide secure access without a key, fuss or worry, ensuring user identities.



A unique combination of convenience & cloneproof peace of mind, the ArchiTech platform uses universally-compatible Bluetooth LE technology, so they can use any smart device to unlock ArchiTech on your door(s); & do so from afar, at a comfortable, customizable range of up to 30 feet away. For even greater security users can add an optional passcode, entered on their phone App.

**iLock App is available from both iTunes and the Google Play Store**

## WEATHER-RESISTANT ALARMED PANIC LOCKS - Models 250, 260, 700, 710

Battery operated alarmed panic locks. All models (except 11A) feature deadbolt & deadlatch for extra security. Selectable 2-minute or constant alarm. 260/710.

All models (except 11A) feature a 2-minute auto re-set on the alarm

<b>Cover:</b>	Die-cast metal
<b>Push Bar:</b>	Extruded Aluminum channel and push bar
<b>Handed:</b>	All models non-handed except 11A
<b>Installation:</b>	Surface mounted for single or double doors
<b>Cylinder:</b>	Accepts most standard size rim cylinders for inside And outside key control (not included)
<b>Power:</b>	Uses 1 9v battery (included). Normal battery life 1 Year. Can be powered by AC power by using either PP100 or AC9.
<b>Lock bolt:</b>	1" throw heavy die cast with reinforced Steel inserts.
<b>Alarm:</b>	Dual piezo siren measured at 95db



Part No.	Special Features	Finish	List Price
250X28WP	Waterproof, paddle	US28	\$659.28
700X28WP	Waterproof, 36" Bar	US28	\$801.51
700X312WP	Waterproof, 33" Bar	US312	\$1,359.49
700X28X48WP	Waterproof, 48" Bar	US28	\$801.51
710X28WP	Waterproof, 2 min auto reset	US28	\$829.64
250X28	Paddle	US28	\$553.23
260X28	2 min auto reset	US28	\$633.59
700X28	36" Bar	US28	\$668.75
700X312	33" Bar	US312	\$1,191.11
710X28	2 min auto reset	US28	\$751.20

## Door Alarm - PG10, PG21 & PG30 SERIES

Battery operated surface mounted door alarms. Alarms magnetically activated. Easy to install. Convenient plug-in "No cut" jumpers.

<b>Power:</b>	PG21, PG30 use 9v battery (supplied). PG10 & LL1 use BP6 (supplied). BP6 must be purchased from Alarm Lock. AC power supply can also be used as a battery back up (see below).
<b>Alarm:</b>	Dual piezo siren measured at 95db.
<b>Cylinder:</b>	Accepts most 1¼" mortise cylinder used for interior activation (not supplied) and standard size rim cylinder used for exterior activation (not supplied).
<b>Installation:</b>	Surface mounted for single or double doors.
<b>Cover:</b>	Die cast metal.



Part No.	Special Features	Finish	List Price
PG21MS	Battery operated surface mounted door alarm	Metallic Silver	\$347.81
PG21MB	Battery operated surface mounted door alarm	Metallic Bronze	\$347.81
PG21MSS	Battery operated surface mounted door alarm w/ a Strobe	Metallic Silver	\$448.54
PG21MBS	Battery operated surface mounted door alarm w/ a Strobe	Metallic Bronze	\$448.54
PG30MS	Battery operated surface mounted door alarm	Metallic Silver	\$435.05
PG30MB	Battery operated surface mounted door alarm	Metallic Bronze	\$737.95
PG30KPD	Remote Keypad		\$251.20

## DELAYED EGRESS PANIC LOCKS

Stand alone delayed egress panic lock. 15 second delayed latch, instant alarm. Instant egress in case of emergency or fire. Meets NFPA 101 Life Safety Code. Includes monitoring output for secondary siren, CCTV or remote monitoring. Smoke detector input

<b>Cover:</b>	Die cast metal
<b>Push bar:</b>	Extruded aluminum push bar and channel
<b>Handed:</b>	Non-handed
<b>Installation:</b>	Surface mounted for single or double doors
<b>Cylinder:</b>	Accepts most standard size rim cylinder used for inside and outside key control
<b>Power:</b>	AC powered with 9v battery back-up for siren. Transformer And armored cable included
<b>Lock bolt:</b>	1" throw heavy die cast with reinforced steel inserts
<b>Alarm:</b>	Dual piezo siren measured at 95db



Part No.	Special Features	Finish	List Price
715X28X88	15 second delayed egress lock w/ monitoring output, 33" bar	Aluminum finish	\$1,321.01
715X28X88X48	15 second delayed egress lock w/ monitoring output, 48" bar	Aluminum finish	\$1,336.99

## Accessories

Part No.	Description	List Price
104X12	LEKTROLOKS 104RAX12V	\$985.31
103	KTRLKS DEADBOLT 24VDC FAIL SF	\$538.92
CEM-KD	MORTISE CYLINDER KEYED DIFF.	\$46.13
CEM-12345	MORTISE CYLINDER KA 12345	\$46.13
730X312	SINGLE DOOR KEEPER 312 FN	\$67.76
730X28	SINGLE DOOR KEEPER US28 FN	\$67.76
732X28	KEEPER DOUBLE DOOR #28 FINISH	\$67.76
732X312	KEEPER DOUBLE DOOR #312 FINISH	\$67.76
767X28	BACKPLATE US28	\$31.72
S6173	700/250 WP BATTERY	\$53.34
BP6	BATTERY 6V FOR PG10 & 11A	\$53.34
SWK715	SURFACE WIRING KIT MODEL 715	\$135.07
271	DOOR LOOP DBLE ARMORED CABLE	\$80.74
CER-KD	Standard rim cylinder	\$46.13
CER-12345	Standard rim cylinder	\$46.13

## Air Access



Part No.	Description	List Price
AA-KIT1A	Starter Kit X-Forme NetworxPanel Gateway	\$825.67
AA-KIT2APOW	Starter Kit 2 with Gateway and Cellular Communicator	\$1,045.89
AA-GATEWAY	Gen 3 Gateway	\$550.40
AA-GATEWAYPOE	POE Gateway	\$688.03
AA-GATEWAY-PW	Gateway & Power Adapter	\$721.57
AA-LTEA	Plastic AT&T StarLink Radio	\$352.91
AA-LTEA-PW	Metal AT&T StarLink Radio	\$688.03

## E-Access



Part No.	Description	List Price
NAE-1DC	Embedded Single Door Controller in Plastic Housing. Includes 2 Reader Ports (in/out), 2 Relay Outputs & 3 Inputs.	\$1,192.31
NAE-2DM	Embedded 2 Door Controller in Metal Enclosure with Basic Power that is Expandable to 4 Doors. Includes 4 Reader Ports (in/out for each door), 4 Relay Outputs & 6 Inputs.	\$1,948.10
NAE-4DM	Embedded Four Door Controller in Metal Enclosure with Basic Power. Includes 8 Reader Ports (in/out for each door), 8 Relay Outputs & 12 Inputs.	\$2,742.55
NAE-2DMPL	Embedded 2 Door Controller in Metal Enclosure w/ Device & Lock Power. Expandable to 4 Doors. Includes 4 Reader Ports (in/out for ea. door), 4 Relay Outputs & 6 Inputs.	\$2,213.43
NAE-4DMPL	Embedded Four Door Controller in Metal Enclosure with Device and Lock Power. Includes 8 Reader Ports (in/out for each door), 8 Relay Outputs & 12 Inputs.	\$3,007.92
NAE-1DMPL	NA-E EMBED 1 DR PANEL W P/S	\$1,811.02
NAE-8DXLPL	NA-E EMBED 8 DR PANEL W P/S	\$6,232.41
NAE-ACM	Two Door Access Control Module that Expands the Two Door Controller to Four Doors.	\$873.89
NAE-ET5	Mullion Mount Reader. Reads Bluetooth and Mifare Smart Credentials.	\$955.16
NAE-ET10	Mullion Mount Reader. Reads Proximity, Bluetooth & Mifare Smart Credentials.	\$1,055.71
NAE-ET20	Single Gang Reader. Reads Proximity, Bluetooth & Mifare Smart Credentials.	\$1,206.52
NAE-ET25	Single Gang Keypad Reader. Reads Proximity, Bluetooth & Mifare Smart Credentials.	\$1,583.56
NAE- RMC-1S	On-Line License Key that Provides Secure Cloud Remote Management for 1 System.	\$820.27
NAE - API	On-Line License Key for RESTful Application Program Interface. (Push ONVIF for 1 Server)	\$2,021.29
NAE - VT-TD	On-Line License Key for RESTful Application Program Interface. (Push ONVIF for 1 Server)	\$501.28
NAE-Mobile-Cred	ON-line License Key that Provides Mobile Credentials for One System.	\$829.88
NAE-128U	NA-ELIC. KEY U/G TO 128 DOORS	\$1,064.31
NAE-UPRO	Adds advanced features; threat levels, soft-antipassback, dashboard, additional credential types	\$1,215.20
NAE- POE - 1D	POE Power Module for Single Door Controller.	\$75.96
NAE-SWAP2D	Replacement Two door Controller (PCB ONLY).	\$1,405.56
NAE-BP-32-2D	Napco Base line features, Back plan - 2 Doors	\$1,634.72
NAE-BP-32-4D	Napco Base features, Back plan - 4 Doors	\$2,429.17
NAE-MAX-32-4D	Napco Base line features, Hubmax mount - 4 Doors with power supply	\$2,415.22
NAE-1DC-B	Basic 32 Door License, App - Compact 1 Door Access Control Module - 2 Wiegand Readers In/Out, 2 Form C Relays, 3 programmable inputs NO/NC Supervised - 12VDC - 1 NEA-MI-RD-M Reader - 1 NEA-MI-ISO-CRD-25 & 1 NEA-MI-FOB-25 - Requires 12VDC 1 Amp	\$1,387.99

## E-Access (continue)



Part No.	Description	List Price
NAE-2DM-B	Basic 32 - 2 Door Access Control Panel, App - Steel Can housing with key lock, supports 4 Wiegand Readers In/Out, 4 Form C Relays, 6 programmable inputs NO/NC Supervised - Integrated 12VDC power supply with battery backup with 5' IEC cord included. Bundle includes 2 NEA-MI-RD-M Reader - 1 NEA-MI-ISO-CRD-25 and 1 NEA-MI-FOB-25 (Option to add NEA-ACM-2D to control 4 doors in housing)	\$2,173.80
NAE-2DMPL-B	Basic 32 2 Door w/ Lock Power Panel - Steel Can housing with key lock, 2 Door Access Control Module - 4 Wiegand Readers In/Out, 4 Form C Relays, 6 programmable inputs NO/NC Supervised - Integrated 12VDC power supply for controller & readers with 4 selectable by output 12 or 24 VDC, Fire Drop and battery backup w/ 5' IEC cord included. - (Option to add A2M to control 4 doors in housing)	\$2,963.66
NAE-ACM-2DB	Access Control Module 2 Door Expansion - board only - Add on 2 Door PC Board for "2DM & 2DMPL" models - 4 Wiegand Readers - In/Out, 4 Form C Relays, 6 programmable inputs NO/NC - Bundle includes 2 NEA-MI-RD-M Readers - 1 NEA-MI-ISO-CRD-25 & 1 NEA-MI-FOB-25	\$1,118.97
KH36-10	Napco Branded Keyfob, HID 125-kHz Proximity, 36-bit, 10pk	\$48.90

## PROX Readers



Part No.	Description	List Price
NA-300HA	ALPS Single Gang Prox Reader for AL - Napco Branded	\$213.55
NA-500HA	CASCADE Mullion Mount Prox Keypad/Reader for AL - Napco Branded	\$246.42
AL-500HA	ALPS Single Gang Prox Reader for AL - Alarm Lock Branded	\$246.42
AL-300HA	CASCADE Mullion Mount Prox Reader for AL - Alarm Lock Branded	\$213.56

## Credentials

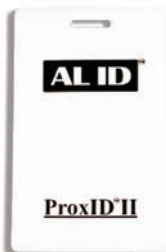

Part No.	Description	List Price
ALHID1391	MicroProx Tag 10 per box	\$154.34
ALID1326	Proximity Access Cards 100 Per Box	\$474.37
ALID1326C/25	PROXCARD2 25 PACK	\$118.59
KH36-10	Napco Branded Keyfob, HID 125-kHz Proximity, 36-bit, 10pk	\$48.90

Coming Soon!



Configure, Command & Control

**MVP EZ™: Perfect for Small & Medium Business Accounts**

Use with Wireless Alarm Lock Locks or Hardwire Napco Access Panels. Configure, Command & Control All from the Smart App on Your Phone.

-  **All-in-One App** - No PCs, no databases—just your smartphone
-  **Fast Setup** - Scan QR codes to enroll locks & access panels
-  **Familiar & Trusted** - Works with Alarm Lock wireless locks & Napco Access Panels
-  **Total Control** - Manage doors, users & schedules from anywhere
-  **Easy to Sell** - Flat-rate, budget-friendly pricing per door
-  **More Ways to Earn** - Adds a steady new stream of income beyond installs
-  **Grows with Customers** - Scalable solution, better service, more revenue, Easy migration path to MVP Access™ version for more advanced system requirements.



Cloud-Based Services Create Happy Customers & RMR



## MVP Access & MVP EZ App-/Cloud-Based Platform & Select Available Hardware Options



Part No.	Description
<b>MVP EZ Platform with By-Door Rate (Order on <a href="http://www.napcocomnet.com">www.napcocomnet.com</a> (following 1x dealer signup))</b>	
MVP-DOOR-P	MVP Cloud Services, Door 1 Primary (1st)
MVP-DOOR-2-8	MVP ", Doors 2 through 8
MVP-DOOR-9PLS	MVP ", Doors Over 9 (9+)
MVP EZ App	MVP EZ App for smartphone setup & control of MVP EZ systems (no database or PC req'd). Downloadable for Apple & Android smartphones (see App Store or GooglePlay).
MVP-IM3-POE	Dedicated MVP POE Gateway, Gen. 3 Power Over Ethernet, No AC power required
MVP-IM3-80211	Dedicated MVP Combo Gateway, Gen 3 Wired/Wireless, supports wireless or hardwire Ethernet connection
MVPDL6200/26D	MVP-Ready Trilogy Networkx Cylindrical Prox/PIN Lock with HID reader, Door Position Switch/REX, interior indicator, key override, and preloaded MVP firmware for use with MVP EZ and MVP Access Cloud Management platform, standard core, 26D finish.
MVPDL1300NW26D1	MVP-Ready Trilogy Networkx narrowstile wireless access prox lock trim with HID Prod ID reader, preloaded MVP firmware for use with MVP EZ and MVP Access Cloud Management platform, 26D finish.
MVPN90T1195F26D	MVP-Ready Trilogy Networkx ArchiTech Designer Cylindrical Prox Lock, with surface mount electronics, HID oval prox reader, Bluetooth support, and separate leverset (American). Preloaded MVP firmware for use with MVP EZ & MVP Access Cloud Management platform. 26D finish.

### Select Popular Door Hardware Options for Use with MVP Platform

Part No.	Description
NA-1	<b>Napco Access 1-Door Controller</b> - MVP Cloud-Ready for EZ or Enterprise Access Platforms, 1 Door, 1 Door Relay @ 2A, 1 Console Relay @ 5A, 1 Wiegand (in-Reader); RS485/OSDP Support (optional out-Reader); 12,500 credentials, 1K access groups, 2.5A power supply (plug-in wall Xformer) or optional POE module); 1.7A power available for all accessory devices; 12V AUX output, Wet Relay & Readers, 4 Inputs: 1 Door Position, 1 REX, 1 Dedicated Fire, 1 Aux; 625 Event Transaction Buffer; 256 Time Schedules, Onboard Ethernet RJ45, Built-in relay contact overvoltage protection.
NA-2	<b>Napco Access 2-Door Controller</b> - MVP Cloud-Ready for EZ or Enterprise Access Platforms, 2 Door, 2 Door Relay @ 2A, 1 Console Relay @ 5A, 2 Wiegand Readers; RS485/OSDP Support; 25,000 credentials, 1K access groups, 2.5A power supply (plug-in wall Xformer); 1.7A power available for all accessory devices; 12V AUX output, Wet Relay and Readers, 6 Inputs: 2 Door position, 2 REX, 1 Dedicated Fire, 1 Aux; 1250 Event Transaction Buffer; 256 Time Schedules, Onboard Ethernet RJ45, Built-in relay contact overvoltage protection.
PDL620026D	Cylindrical Trilogy Networkx PIN/Prox Lock with built-in HID Prox ID Reader & Door Position Switch/Request to Exit, supports 5K users, 26D finish
PDL820026D	Cylindrical Trilogy Networkx PIN/Prox Lock with built-in HID iClass Prox ID Reader & Door Position Switch/Request to Exit, supports 5K users, 26D finish
PDL1300NWET26D	Networkx Narrow Stile Exit Trim supports most Adam Rite Series Latch Locks & various push bar mfrs, with Built-in HID Prox ID Reader, 5K users, 26D finish
ETPDNI-RX-26D	Networkx access lock trim for various push bar mfrs, with built-in HID Prox ID reader with REX feature, 26D finish
N95S1RW86RFD32D	Mortise, surface mount, oval Prox, plain Rose, Crescent Lever, right Handed, Apartment Function, 5K users, 32D finish

# Be an MVP: 4 EZ Steps to Unlock New Revenue - All from Your Phone

Install Trilogy Network Locks or  
Choice of Napco Access Panels



STEP  
01

Easily Add Remote  
Cloud-Management  
Services in Minutes

STEP  
02

No PC or  
database on  
Their Premises.  
Real-time Control  
Anywhere you are



Earn Monthly Revenue Per Door Per Lock

Affordable Monthly  
Flat-Rate Per Door  
- Easy to Quote  
Provide User Updates &  
Text Alerts, etc.

Sun	Mon	Tue	Wed	Thu
			1	2
3	4	5	6	7
10	11	12	13	14
17	18	19	20	21
24	25	26	27	28
31				

STEP  
03

Build Your Business Bottomline

Grow New  
Revenue Fast:

- By Lock
- By Month
- By Account
- By Year



STEP  
04



Setup/Manage on Your Phone

## MVP Access: A Game Changer for Locksmiths

- ✓ **Build a Recurring Monthly Nest Egg**— turn each install into steady income you can count on in the long run.
- ✓ **Better Lock & MVP Software Integration**— All built by the same trusted manufacturer, ensuring seamless performance.
- ✓ **Remote Management**— change access, schedules door-un/locking & users from anywhere, using an easy App.
- ✓ **Premium Features Customers Want**—mobile credentials with geo-fencing & Text emergency & lockdown alerts & Admin function option.
- ✓ **Stronger Customer Relationships**—lock in long-term clients with an essential service & solidify new business for growing needs.
- ✓ **No On-Site Computer or Database Required at Customers**— MVP Access is cloud-based with automatic updates, & no licensing or drivers to fuss with.



Look for the MVP-Ready for the easiest locks, panels and gateways to add to MVP Cloud, because the MVP-Firmware's already inside!



GET STARTED

## ALARM LOCK SYSTEMS, INC. WARRANTY/RETURN POLICY

Alarm Lock Systems Inc. warrants its products to be free from manufacturing defects in material and workmanship. The length of said warranty is 24 months on all products from the date of manufacture.

Any customer may get an over-the-counter exchange with the original seller (distributor) for any Alarm Lock product failing to operate properly.

For those customers who have direct accounts with Alarm Lock, please follow this procedure to return product for warranty replacement:

1. Email your request to: [returns@alarmlock.com](mailto:returns@alarmlock.com)
2. In order to receive a return authorization number, you must provide the date code of the product.
3. The 4-digit date code sticker is the actual expiration date of the warranty.
4. Any out of warranty product returned to the factory will be scrapped and is not returnable.
5. If said product is found not to be operating properly because of a factory defect and is within the warranty period, Alarm Lock will issue a product replacement.

If you experience a problem with any Alarm Lock product, you may contact Alarm Lock's Technical Support directly at 1 800 252-5625.

All prices published are suggested list prices in US Dollars. Some specifications are preliminary and subject to change without prior notice (Subsequent Tariffs/Surcharges May Apply.). Not responsible for typographical errors. Alarm Lock Systems, LLC, is a Division of Napco Security Technologies, Inc. (NASDAQ:NSSC) © Alarm Lock Systems, LLC, 12.1.25



Alarm Lock Systems, Inc.  
345 Bayview Ave  
Amityville, NY 11701  
1 800 252-5625  
1 631 789-3383  
[www.alarmlock.com](http://www.alarmlock.com)

All prices published are suggested list prices in US Dollars. Some specifications are preliminary & subject to change without prior notice (Subsequent Tariffs/Surcharges May Apply.). Not responsible for typographical errors.

Alarm Lock Systems, LLC, is a Division of Napco Security Technologies, Inc. (NASDAQ:NSSC)

ALA132C © Alarm Lock Systems, LLC, 12.1.25